

PRESS BRAKE

MP3003CNC

NS: 2024-257

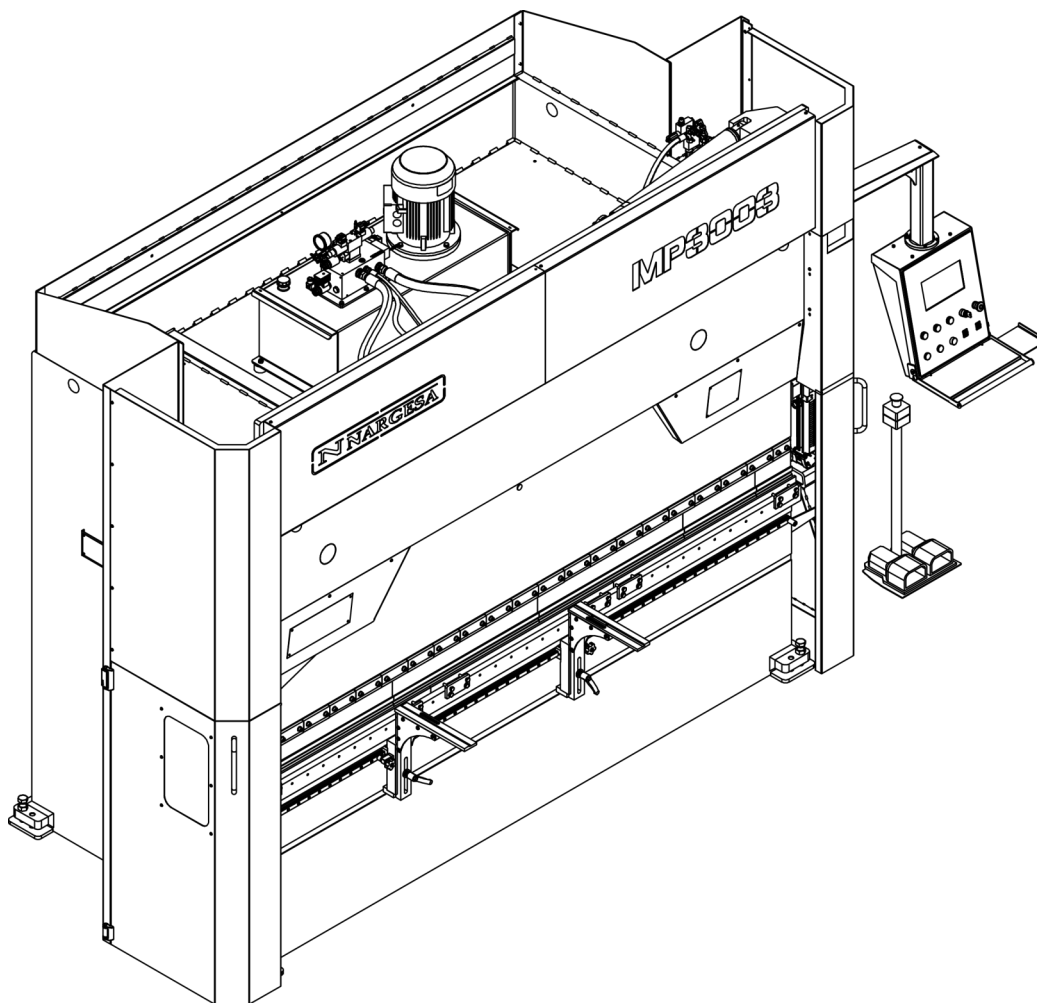

INSTRUCTIONS BOOK

PRADA NARGESA, S.L

Ctra. de Garrigàs a Sant Miquel s/n · 17476 Palau de Santa Eulàlia (Girona) SPAIN

Tel. +34 972568085 · nargesa@nargesa.com · www.nargesa.com

NARGESA CLIENTS

Prada Nargesa has more than 8.000 customers around the world. Some of our clients, those who offer service to third parties with the Nargesa machinery in their workshops, have been pleased to be part of this network that aims to connect them with possible future clients. In this way, all those people or companies that have a need for any part or tool that can be manufactured by using the Nargesa range of machinery, will be able to find a solution in their area to be able to satisfy their production requirements by hiring their services.



We have more than 8.500 customers in 150 different countries around the world

Discover its location on the interactive map on our website!

DO YOU WANT TO PARTICIPATE?

Send an email to nargesa@nargesa.com, include the following information and we will add you to this list.

We want to encourage all those who haven't participated yet in this great commercial network!

1. Company name
2. CIF/Tax Code
3. City
4. Country
5. Machine or machines

PRADA NARGESA

Prada Nargesa S.L. is a family business founded in 1970 located near Barcelona, Spain, with more than 50 years of experience in the sector of manufacturing of industrial machinery, and more than 10.000m² of facilities. Nargesa is a symbol of quality, reliability, warranty and innovation.

Our whole range of machines and accessories is manufactured entirely in Nargesa. We have a constant stock of 400 machines, and we have more than 16.800 machines sold all over the world.



OUR RANGE OF MACHINERY

Ironworker Machines

Ring Roller Bender and Pipe Bender

Non-mandrel Tube and Pipe Bender

Twisting / Scroll Bending Machines

Horizontal Press Brakes

End Wrought Iron Machines

Gas Forges

Iron Embossing Machines

Hydraulic Shear Machines

Hydraulic Press Brakes

Presses for Locks

Broaching Machines

Power Hammers

CERTIFICATES

Prada Nargesa has several certifications that backup both, the design and manufacturing processes, as well as the journey through exporting our products around the world and the quality of the manufacturing components we use for our machines. These facts turn into real advantages for our customers:



AUTHORIZED EXPORTER

- Faster customs procedures
- Reduction of tariff documentation
- Tariff preferences according to geographical location



INNOVATIVE SME

- Development in innovation, design and manufacturing technologies
- Certification and audit of efficiency in product and service
- Ability to foresee customer needs



R+D+I MANAGEMENT

- Manufacturing based on the R+D+I process
- Technological surveillance system

SUCCESS STORIES

At Prada Nargesa we believe that the testimony of our clients is our best guarantee, and that is why we like to expose some of the success stories that we have witnessed around the world:



Discover its location on the interactive map on our website!

DO YOU WANT TO PARTICIPATE?

Send an email to nargesa@nargesa.com including the following information and we will add you to our website

Company name

Testimonial name

Post in the Company

Country

Descriptive text

Photography with the machine

INDEX

1. CHARACTERISTICS OF THE MACHINE	4
1.1. General dimensions	4
1.2. Description of the machine	4
1.3. Identification of the machine	5
1.4. General features	6
1.5. Accessories	6
1.5.1. Description of accessories	6
1.5.2. Tooling	7
1.6. Description of safety devices	8
2. TRANSPORTATION AND STORAGE	9
2.1. Transportation	9
2.2. Storage conditions	9
3. MAINTENANCE	10
3.1. General Maintenance	10
4. INSTALLMENT AND START UP	13
4.1. Location of the machine	13
4.2. Dimensions and working site	13
4.3. Admissible outer conditions	13
4.4. Connection to power supply	14
5. ADJUSTMENT OF THE BACK GAUGE HANDLES	15
6. FOLDING GROUP REGULATION	17
7. WARNINGS	18

ANNEX 1. SOFTWARE ESA S630

ANNEX 2. TECHNICAL FEATURES

1. CHARACTERISTICS OF THE MACHINE

1.1. General dimensions

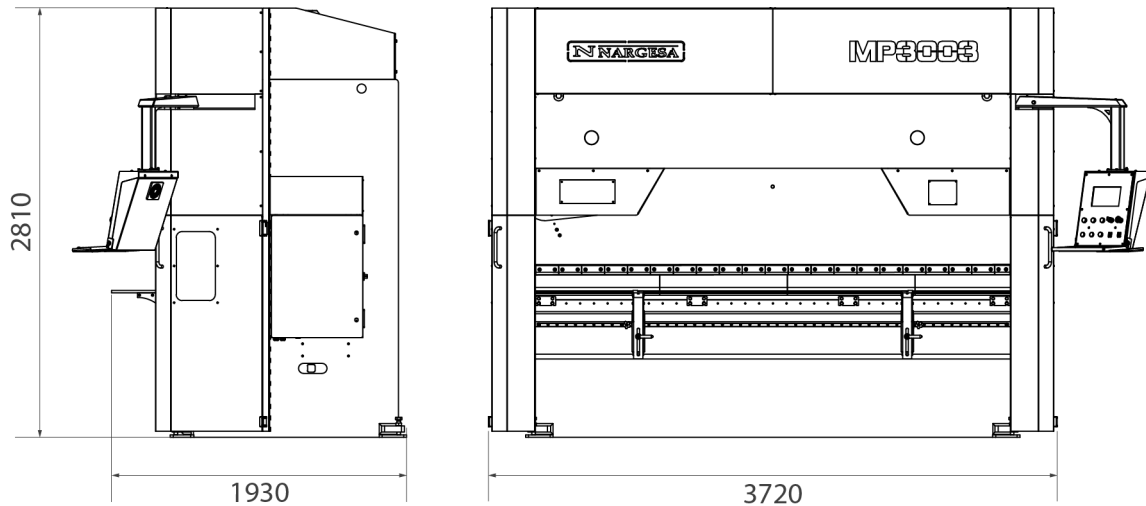

1.2. Description of the machine

The MP3003CNC press brake, is designed specifically for folding sheet in different degrees, any application other than specified above, exonerates the manufacturer from any responsibility for the damage to the machine or the people who use it.

The MP3003CNC is according to the European standards and directives for the manufacturing of industrial Machinery.

1.3. Identificación de la máquina

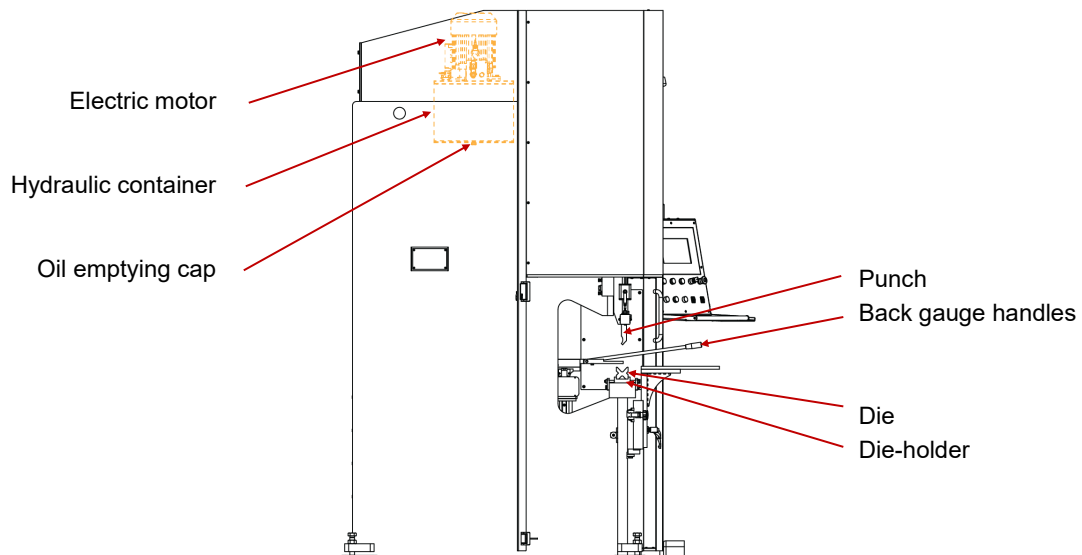
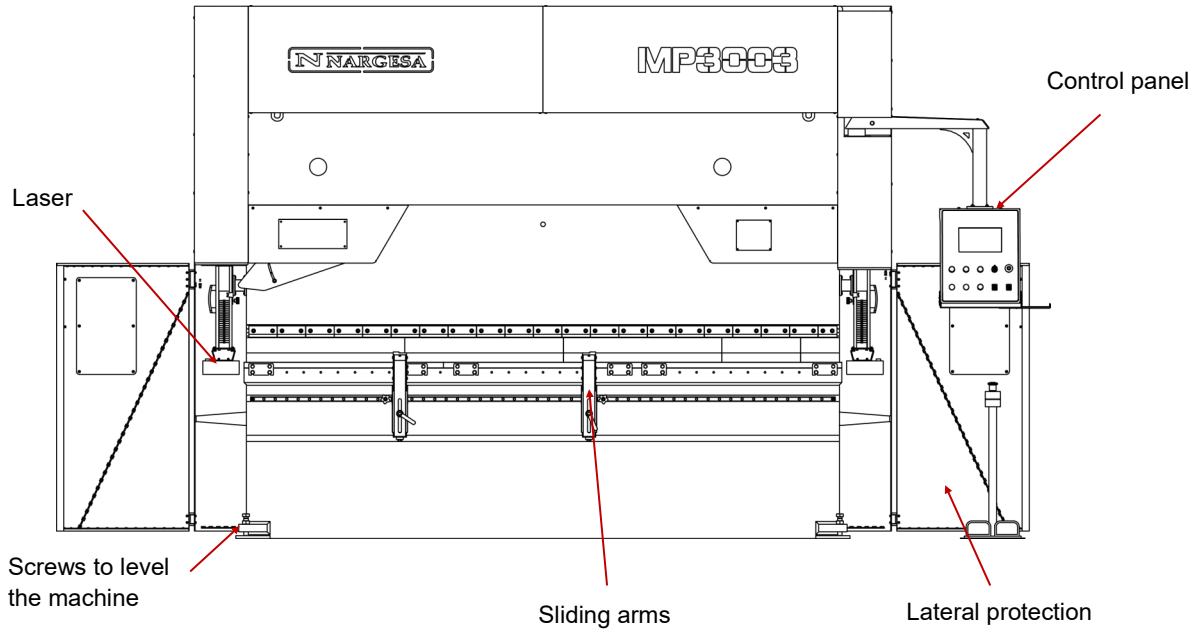



1.4. General features

Motor	9,5 KW (12 CV) a 1400 r.p.m
Intensity	19 A a 400 V 32 A a 230 v
Pressure of the hydraulic pump	225 kg/cm ² (22,5 MPa)
Pump	22 l/m
Deposit	100 liters
Double acting piston	120 Tm
Neck	320 mm
Inner folding lenght	2700
Total folding lenght	3125 mm
Total displacement of top	600 mm
Maximum punch displacement	160 mm
Total weight	9100 Kg

1.5. Accessories

1.5.1. Description of accessories

The punch and die are treated, ensuring reliability and endurance under normal use. Arrays have different openings for different thicknesses of sheet metal and bending radi.

1.5.2. Tooling

The press brake MP3003CNC, has been designed for the use with "V" dies, punch and die holder.

Other dies with upper V's sectioned punches and press brake anvils can be also used. Please ask the manufacturer.

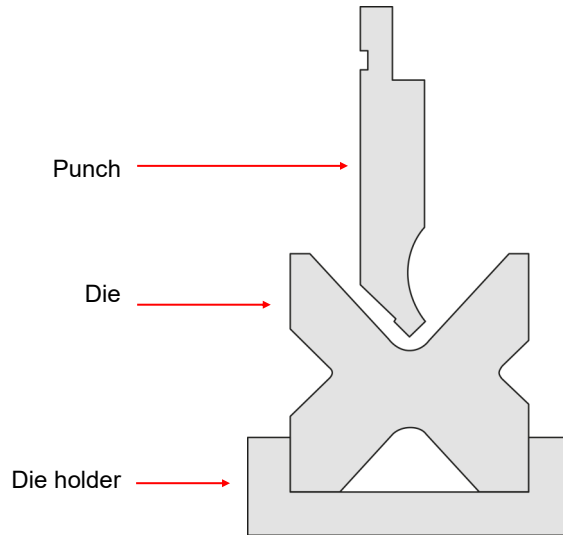

Ton/m																							
V	H	Ri	E = mm 42 - 48 kg/mm ²																				
			0,5	0,8	1	1,2	1,5	1,8	2	2,5	3	4	5	6	8	10	12	15	20	25			
4	2,6	0,7	4	10,5																			
6	3,9	0,9	2,5	6,5	10																		
8	5,2	1,5	2	5,5	8	11,5	18																
10	6,5	1,7		4,1	6,5	9,5	14,5	21	26														
12	7,8	2			5,5	8	12	17,5	21,5	33,5													
16	10,4	2,7				6	9	13	16	25	36												
20	13	3,4					7,5	10,5	13	20	29	52											
26	18	4,2						8,5	10,5	16	23	41	64										
30	20	5								14	19	34	54	77									
35	23	6									17	30	46	66									
42	27	6,7									15	26	40	58	103								
45	29	7,5									23	36	52	91									
50	32	8,5									21	32	46	82	128								
60	39	10									27	39	69	107									
70	45	11,7									33	59	92	132									
80	52	13,5									29	52	80	116	180								
90	58	15										46	71	103	160								
100	65	17										41	64	93	144	256							
110	71	18,5											59	84	131	233							
120	78	20											54	77	120	213							
140	91	24												66	103	183							
170	110	29													55	85	151						
200	130	35														72	128	200					



www.nargesa.com

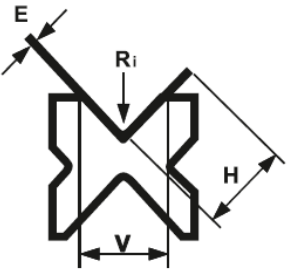

PRADA NARGESA S.L. • SPAIN • Tel. +0034 972568085 • nargesa@nargesa.com

1.6. Description of safety devices

Fixed safety devices consisting of CNC press brake MP3003CNC are the side shields to prevent manipulation of tooling on the sides and guards at the rear of the machine covering the belts and pulleys of the rear gauge.

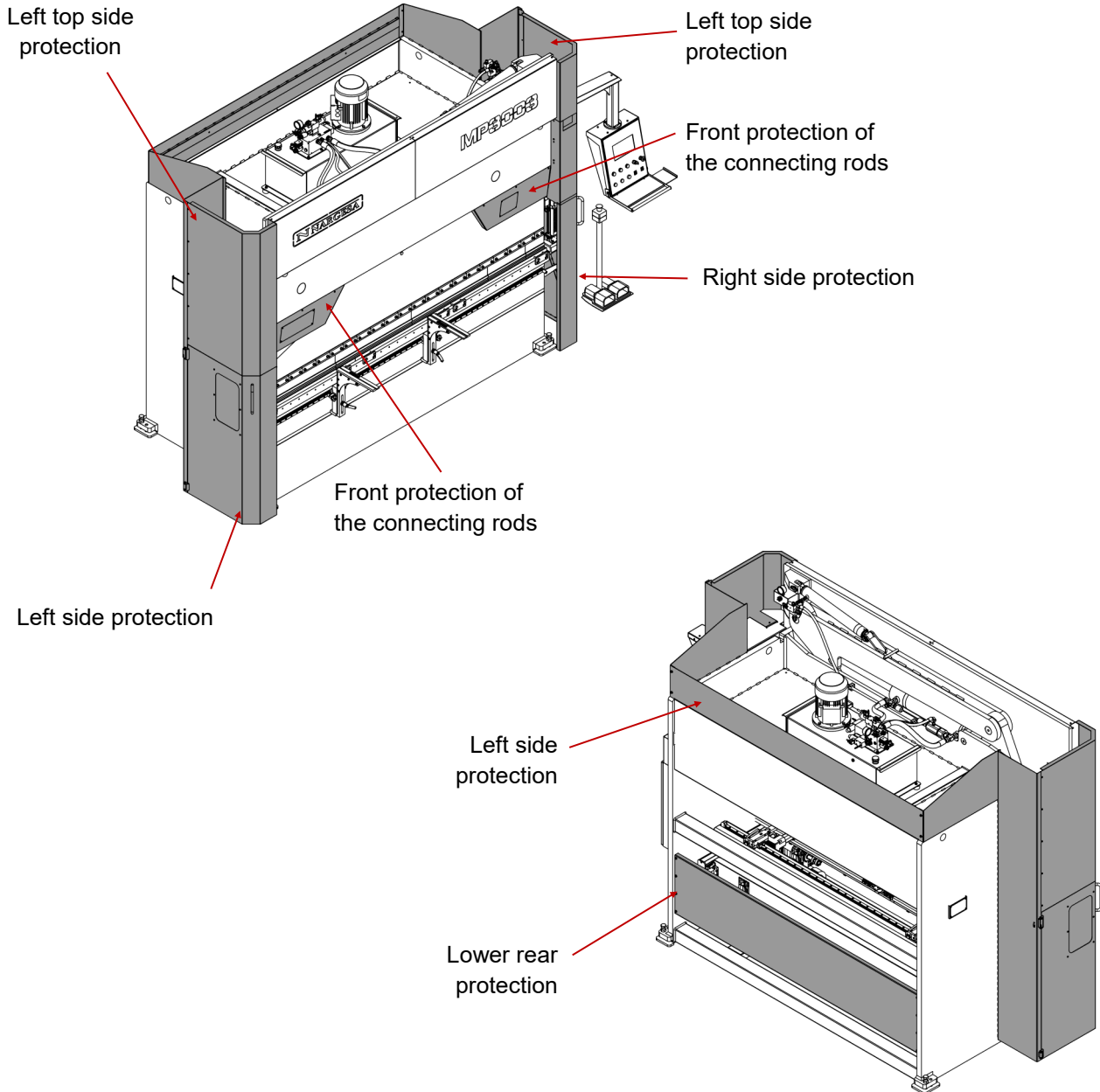

You can not remove the protective caps unless it is for maintenance and it should be carried out by technically trained personnel. PRADA NARGESA will not responsible for damage caused by not adhering to the afore mention instructions.

2. TRANSPORTATION AND STORAGE

2.1. Transportation

Lifting should be performed by a crane, on the marking point to that end anchorage. The machine will never rise by anywhere else other than the specified and provided the two points of the front of the machine will be used because the weight is found mostly in the front so we will make the machine remain in a horizontal line when raised.

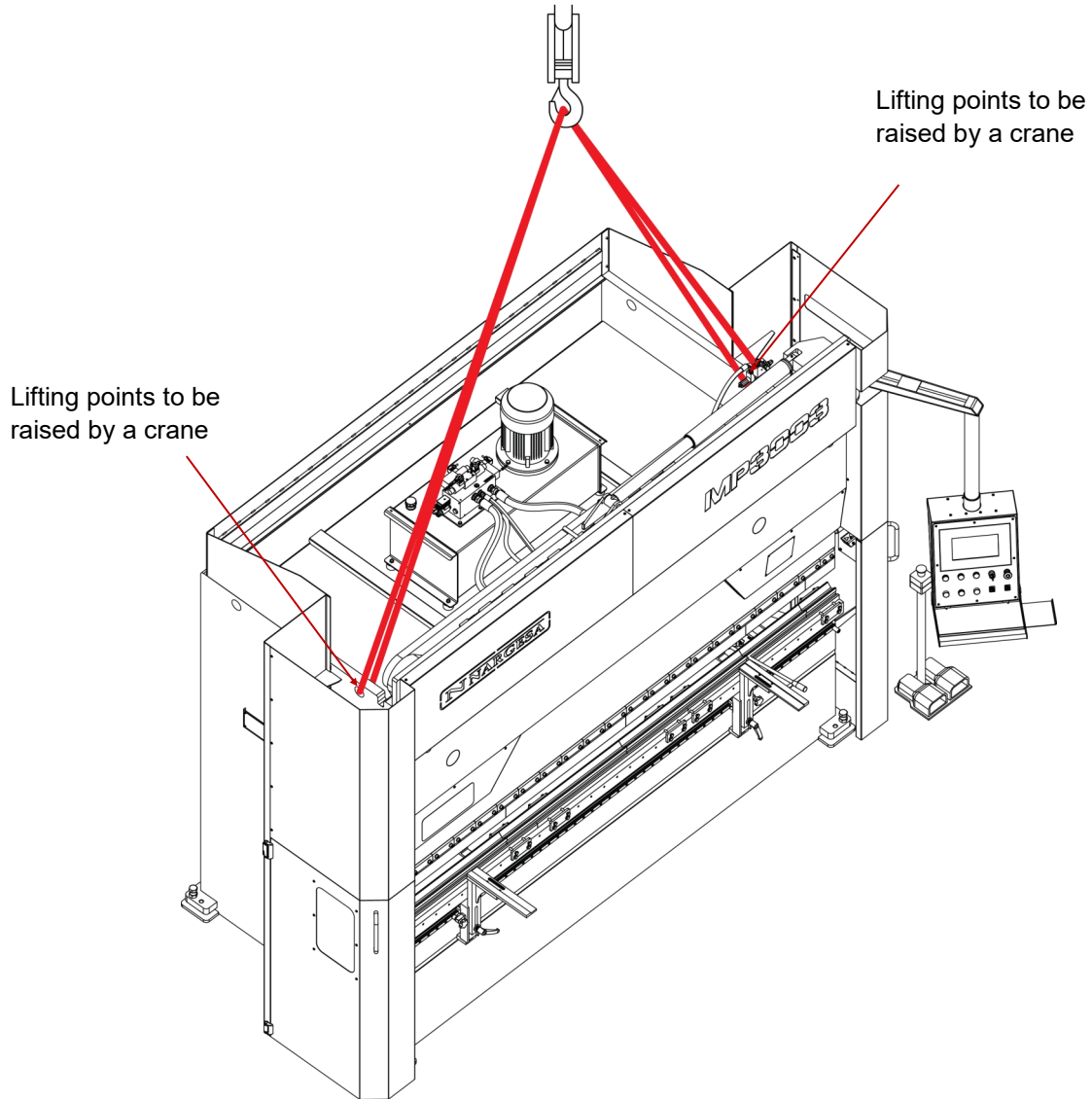

2.2. Storage conditions

Press brake will not be never stored in a place where the following conditions are not settled:

- * Humidity between 30% and 95% non-condensing.
- * Temperature -25 to 55 ° C or 75 ° C for periods not exceeding 24 hours (remember that these temperatures are in storage)
- * It is advisable not to stack heavy objects on the machines.
- * Do not disassemble for storage.

3. MAINTENANCE

3.1. General maintenance

At the top of the tank there is the level sightglass. In the absence of oil, fill up to the mark of the peephole.

- Every 1000 hours of use, check the oil level in the tank.
- Replace oil every 4,000 hours of work.

Oil Type: SIL POWER HV-46

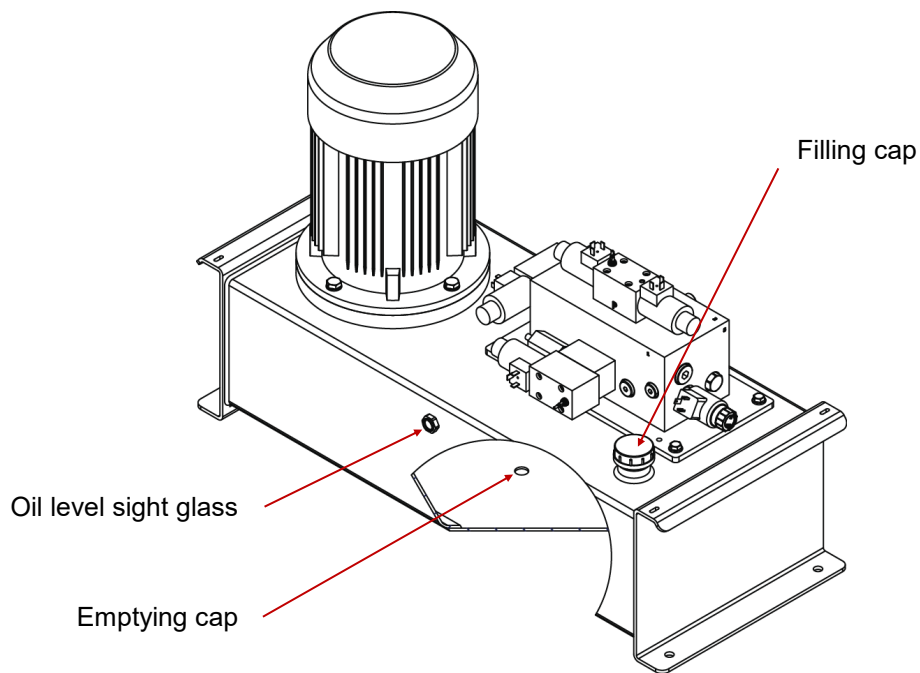

WARNING

Stop the machine in order to carry out the maintenance of the machine. In case of replacement of the oil, start the engine and depress the flashing time increasing the pressure gradually until the circuit is complete.

➔ Grease the boulders fixing rods and piston periodically depending on use. **As a whole 11**

If the use is daily and continuous, grease each month.

➔ Grease all guide accessories every 6 months. **As a whole 2**

Sectionned view of the machine

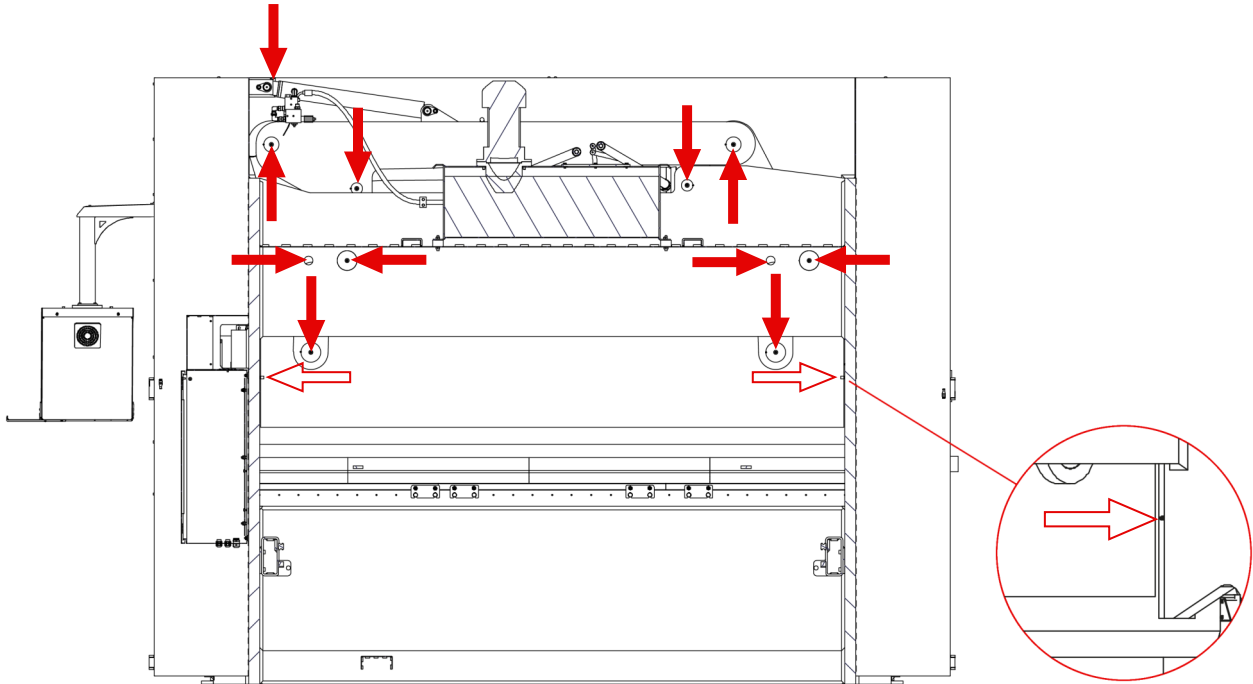

➔ Lubricate all sheet holders greasers. **As a whole 2**

Front view of the machine

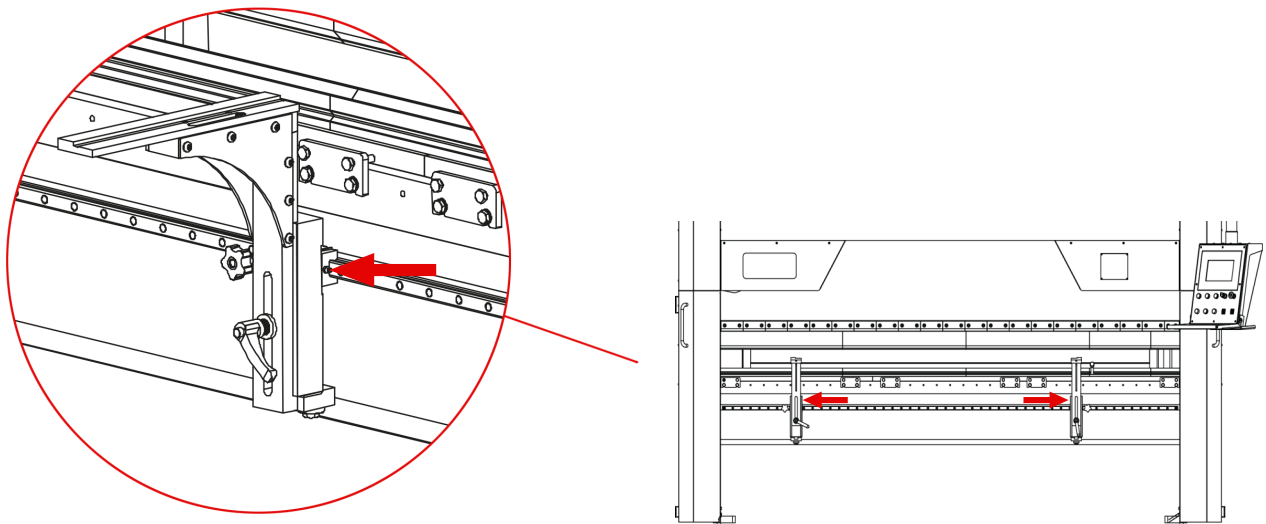

→ Lubricate all gauge greasers. **As a whole 10**

→ Lubricate all racks on axis X and Axis R. **As a whole 4**

Back view of gauge

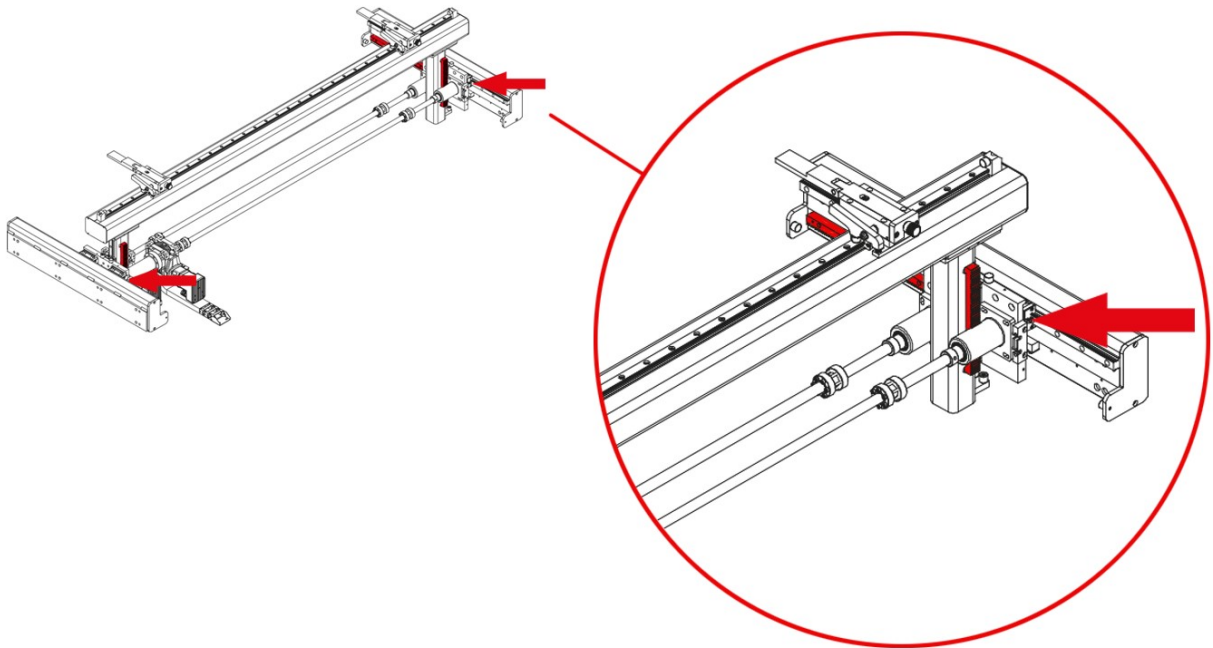

Front view of Gauge

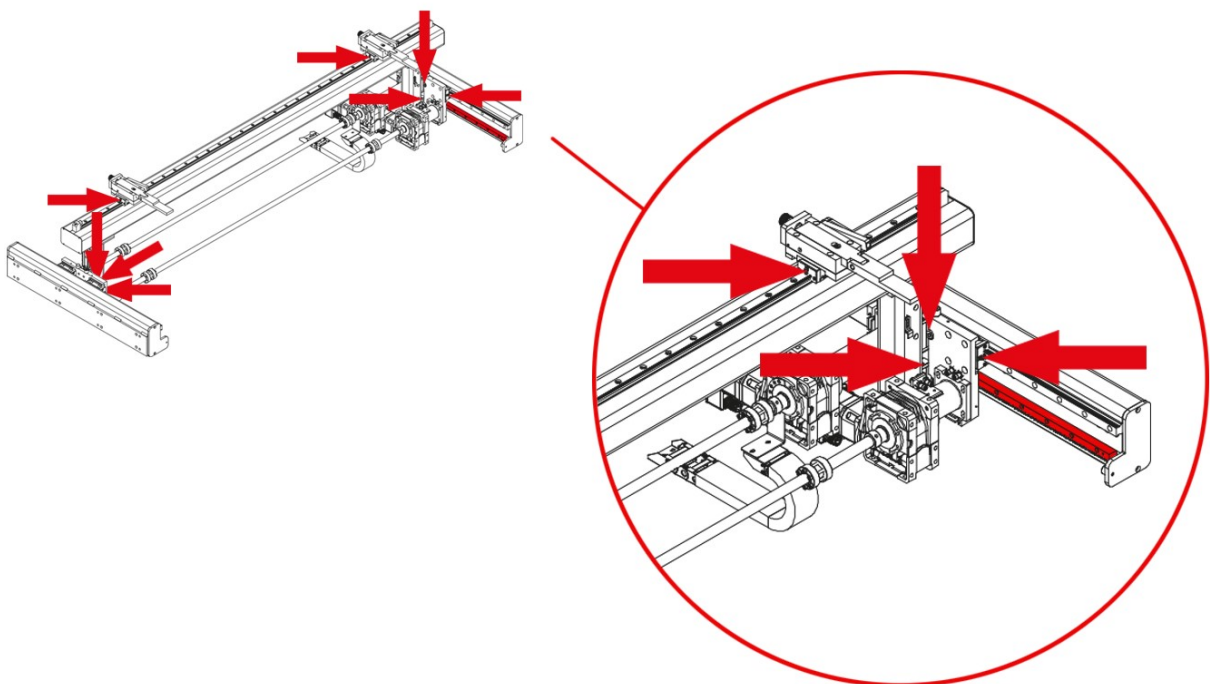

4. INSTALLMENT AND START UP

4.1 Location of the machine

It is advisable to locate the machine properly to avoid having to move it; otherwise it would be required to follow the guidelines outlined in the transport section (# 2). It should be placed on a flat, level surface to prevent vibration and movement during folding operations. It is possible to level the machine by screws at the base of the machine one at each corner.

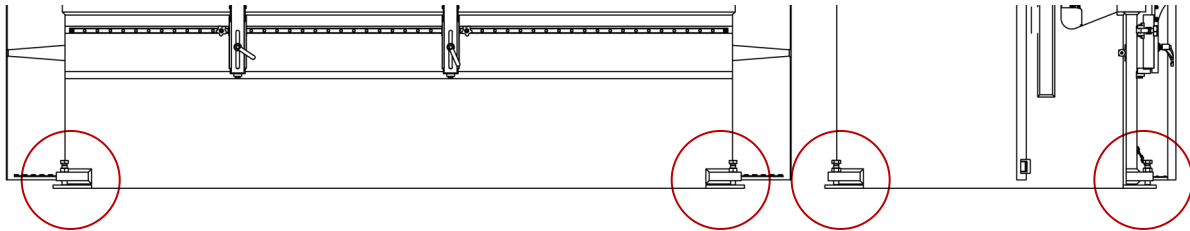

4.2 Dimensions and working site

When the machine is placed it must be taken into account its size, the workspace of the operator and the possible lengths of the workpiece.

The machine can be used by a single operator, which must be placed frontally to the machine, never in a side area since he should control the whole machine and also the main protections are designed for the front use of it.

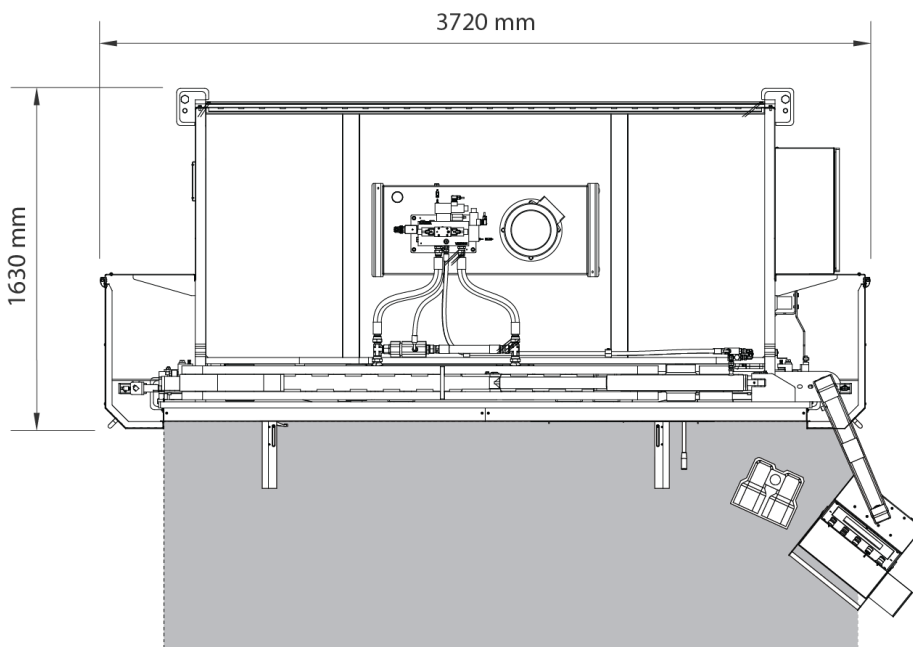

4.3 Admissible outer conditions

Ambient temperature between $+5^{\circ}\text{C}$ and $+50^{\circ}\text{C}$ without exceeding an average temperature of $+45^{\circ}\text{C}$ 24h
Humidity between 30% and 90% non-condensing.

4.4. Connection to power supply

IMPORTANT: This machine must be connected to a 400V outlet with a neutral earthing contact as well.

The MP3003CNC, is equipped with a three-phase motor 230V / 400V star connected 9,5 Kw for connection to a 400V power supply. It must be connected to a single power supply with the power source indicated. If the line voltage is not the one indicated it will be necessary to proceed to change the connection of the bobins of the motor of the hydraulic unit as follows:

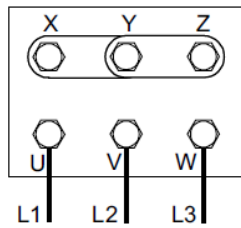

Star shape
(preset)
For tension 400V

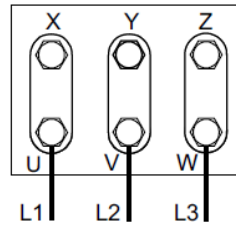

Triangle shape
For tension 230V

The gauge activation is done by a servomotor which does not require any action when making a tension change from 400v to 230v or the other way around.

The inverter configuration will have to be modified as well, as indicated in the following pictures:

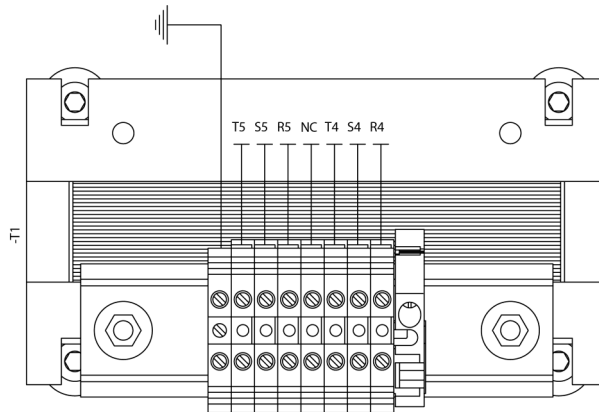

Configuration
400V

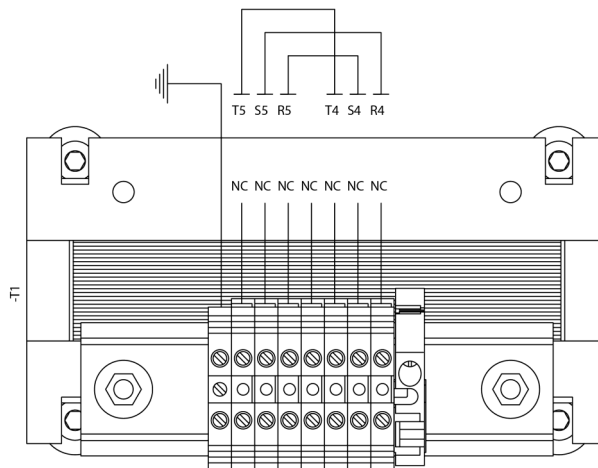

Configuration
230V

5. ADJUSTMENT OF THE BACK GAUGE HANDLES

When it becomes necessary to change the press brake gauge needles position, it will be done by an activation bar provided for such operation and from the machine front side.

It is completely forbidden to carry out this operation without the activation bar.

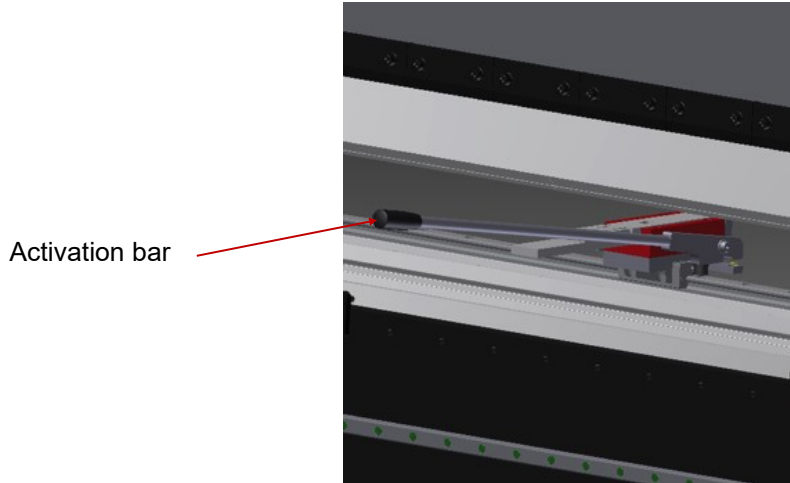

In order to proceed with the movement of the needles, we insert the activation bar in the existing slot there in the needles support.

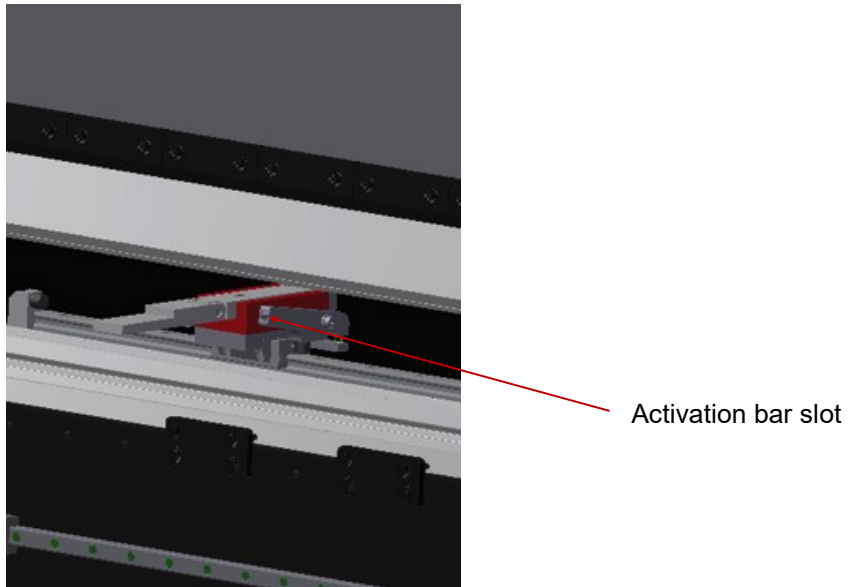

We raise the lever, releasing the needle support and we can move the needle to a new desired position.
We lower the lever and the needle will remain fixed in the new position.

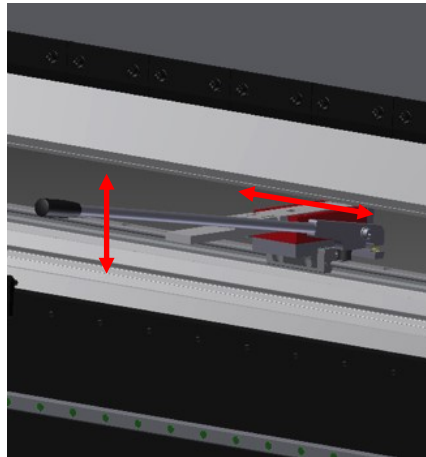

We take the lever off and we have the gauge ready to be used again.

WARNING: Make sure we have removed the lever before starting up the press brake again.

6. FOLDING GROUP REGULATION

Because of continuous use of the press brake it may happen that the machine does not make the same bending angle on the right side than on the left side.

When this happens it is necessary to scale this part by using a lever on the left of the machine and following the steps below:

- Prepare a few metal sheets with dimensions of 100x60x2 mm thickness.
- We removed the left frontal protection to expose the regulation lever.
- We place the die with the 16 "V" which is corresponding to a sheet 2mm thickness..
- We adjust the machine to make a folding operation wider than 90°. 120° is a suitable angle to observe differences.
- We place a plate at each end of the die, respecting both are at the same distance from the end and the bending length is the same.
- We make a folding operation with the sheets and compare one another, taking into account which is which. If we see that the plate on the left is more open than the one at the right, then we must lower the lever to force the ram down and close the angle. Otherwise it will be necessary to lift the lever to force the ram up and open the angle.
- We loosen the fixing screw, move the lever, then we press the lever fixing screw and re-check.
- Repeat the above operations after each test as several attempts are often necessary before getting the optimum position.
- Once the Folding group (Tranche) has been adjusted, fasten the fixation screw to fix the lever and proceed to the assembly of the cover sheets.

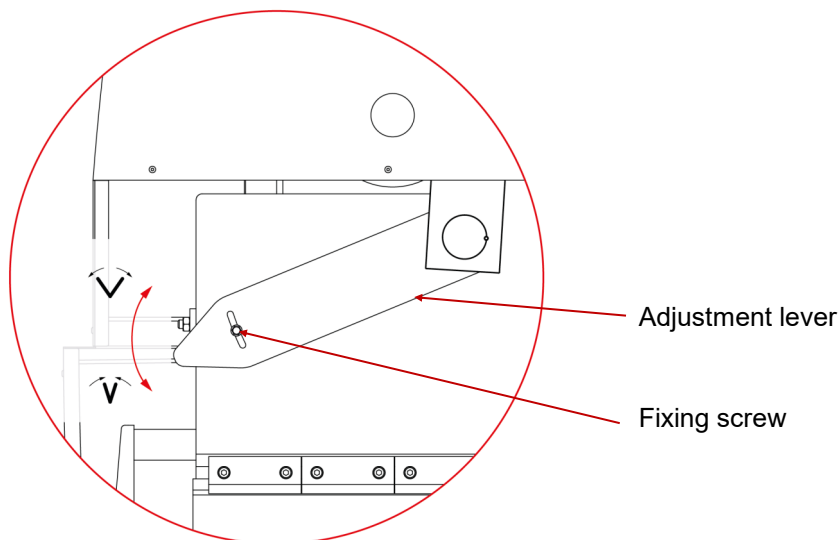

CAUTION

Never move the adjustment lever while the folding group is forcing against the die.

7. WARNINGS

Do not manipulate components of the machine while it's running.

Do not use the machine for any other purposes but the ones described in this manual

Use gloves for handling machine components during the folding process .

Wear safety goggles and protective boots approved by the EC.

Hold the material at the ends, never by the part of the fold .

Do not work without the protections fitted to the machine.

Maintain a safe distance between the machine and the operator during the time the machine is running.

Do not use any other tooling but the ones supplied by NARGESA.

The dies that may be coupled to the machine must always be set and fixed.

In case of accident by negligence of the operator, for not following the safety and operating standards set out in the manual, NARGESA SL will not accept any responsibility.

Bear in mind the obligation for all operators working with the machine to wear goggles, gloves and safety shoes.

Description of the marks on the machine. It's marked on the front with the following hazard symbols.



Annex 1
Software ESA S630

SUMMARY

Notes	5
1. MACHINE SETUP	10
1.1. Ram reference	10
1.2. Back-gauges axes reference	10
2. PUNCHES AND DIES SETUP	11
2.1. Punches and dies list	11
2.1.1. How to enter a new punch	14
2.1.2. Punches to draw	15
2.1.3. Pre-set punches	19
2.2. How to enter a new die	20
2.2.1. Dies to draw	21
2.2.2. Pre-set dies	26
3. PROGRAMMING	27
3.1. List of programs	27
3.2. Entering a numeric program	30
3.3. Entering a graphic program (Optional in the S630 model)	33
3.4. Automatic calculation of the bending sequence (Optional in the S630 model) ...	41
3.5. Manual calculation of the bending sequence	44
3.6. How to bend a box	46
3.7. Work data	46
3.8. Execution of a program in automatic mode	46
3.9. Selection of the DIN formula to calculate the stretch	50

Explanation of the symbols

There may be graphic symbols alongside the text. These are used to highlight particularly relevant information.



Attention: This symbol is used when failure to observe the appropriate precautions could cause slight damage to property or injury to persons



Danger: This symbol is used when failure to observe the appropriate precautions or the performing of incorrect manoeuvres could cause serious damage to property or injury to persons.



Important: This symbol is used in the document to indicate the presence of particularly important information. It means that it is essential to read and fully understand this section of the document.



Options: This symbol is used to indicate sections of the document that describe functions or components that can be optional. The use of optional functions must be agreed upon with the machine manufacturer and are not for free.



Manufacturer: This symbol is used to indicate sections of the document reserved for the machine manufacturer.



Passwords: This symbol is used to indicate sections of the document that describe functions with access controlled by software access passwords.

Printing conventions

To facilitate the identification of the information in this document, use is made of special printing conventions as illustrated below.

Video

The following conventions are used:

- The names of the screen-printed button are highlighted in **bold print** and enclosed in square brackets.
- **[Ok]**. Identifies the button bearing the word **Ok**.
- References to the fields and/or messages on the video are displayed in ***bold print italics***.
- The specific text that has to be entered by the user is underscored.

Text

The following agreements are used:

- *Italics* are used to highlight specialist terms.
- **Bold print** is used to highlight particularly important words.

Glossary



CNC

The abbreviation of Computerised Numerical Control which indicates the apparatus governing the machine, that is, the electronic device via which the work cycles are programmed, the axes are moved, etc... It corresponds to one of the devices, the operation of which is described in this manual.

















SSD

Solid State Disk, also known as Flash Hard Disk, is a data saving device without any components in movement, therefore particularly suited to industrial environments.

Menu selection

To select the contextual menu of the page you must press  one time. Pressing  two times this selection list will appear:

- 0>> Editor**
- 1>> Axis Parameters**
- 2>> Configuration**
- 3>> Diagnose**
- 4>> User Parameters**
- 5>> Shut Down**
- 6>> Cancel**
- 7>> Version**
- 8>> Logo**
- 9>> Monitor Memory**

	Menu		Save to or Load from the internal disk
	Previous		Settings
	Next		Manual
	Save on the USB external memory		Semiautomatic
	Delete		Automatic
	Program list		Stop
	Punches and diez list		Start
	Corrections		Sub menu
			Buttons for manual handling operations

Touch environment

The new interface of the NC Kvara S630 Touch born with a new interactive graphics on which every function is achieved at the touch of your finger. This not only because Prada Nargesa aligns well to the features most current PC environment but also want to speed up and facilitate the work of its end user.

Soft Keyboard

Whenever you have to set some data in the input fields, just type on the screen to edit the data directly with your finger and immediately you will see the Soft Keyboard as shown in the Figure a).

The Soft Keyboard is a virtual keyboard and interactive that has all the functionality of a PC keyboard but with the advantage that being in touch environment, allows the user to have the keyboard directly on the screen so without losing the visual changes and / or entries made to their work, thus speeding up all the useful operations.

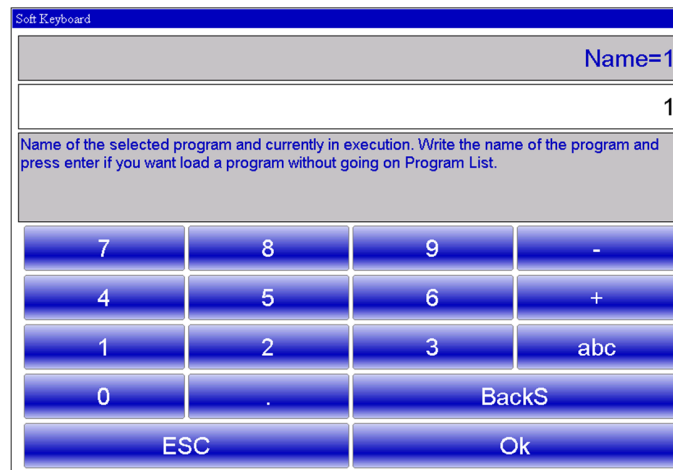

Figure a) Soft Keyboard Numbers

The  key means Delete

The  key means Confirm - ENTER

When you confirm an inserted data, the Soft Keyboard closes

- Pressing "abc" will appear in the literary characters to nominate programs, tools or to set data:

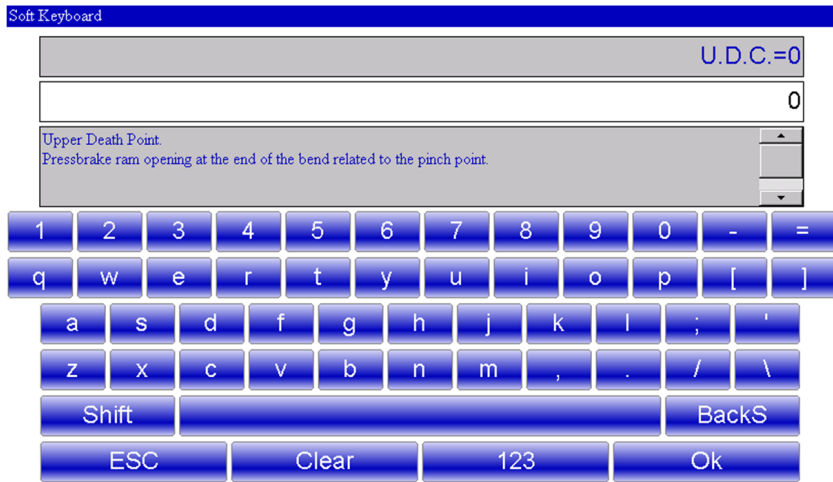

Figure b) Soft Keyboard the literary characters

1. MACHINE SETUP

Operations to execute after powering





It is **obligatory** reference the ram in order to access the automatic phase and execute a work program.

The reference of the back-gauges axes is also **mandatory**. It is done automatically. This is done to avoid doubts about the correctness of the current back-gauges axes targets because they could not be correct if an axis was moved manually when the numeric control was off.

1.1. Ram reference

Comply with the following procedure to reference the ram:

- Press 
- Press 
- If the ram is up, press the **down pedal** to move it down **below the zero mark**. Otherwise, if the ram is already down, it will start the re-ascent automatically (skip the next step).
- While the **down pedal** is pressed, when the **ram downs below the zero mark it stops**. Then, **release the down pedal**. This operation will activate the ram re-ascent automatically.

The ram will move upwards until it meets the zero mark of the optic linear scale where reference takes place. It will now be possible to execute a program in automatic mode.

To repeat the reference procedure without turning off the NC:

- Press **[Repeat Reference]**.
- Follow the steps described above..

1.2. Back-gauges axes reference

To reference the back-gauge it is necessary to follow the steps below:

- Press 
- Press 

The back-gauges axes move towards the reference limit switch. Once the limit switch has been touched, they will reverse their direction and, after having released the limit switch, they will reference to the first zero mark of the encoder.

2. PUNCHES AND DIES SETUP

2.1. Punches and dies list

Comply with the following procedure to access the tools list:

- Press  ; to display the list of punches or list of dies.
- If the list of dies appears, press again  to display the punches, or vice versa.

The following window will appear in the case of punches:

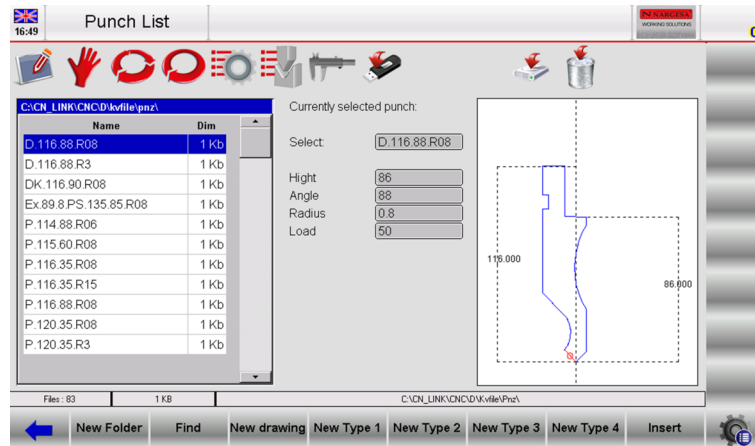

Figure 1 Punches list

The window on the left is the punch list window.

The central boxes show the data related to the selected punch (highlighted by the cursor).

The window on the right gives a preview of the punch to which the cursor has set.

The following window will appear in the case of dies:

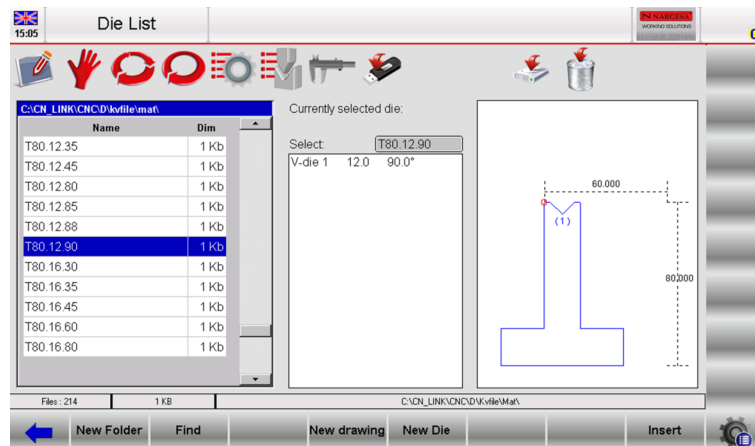

Figure 2 Dies list

The window on the left is the die list window.

The central boxes give the data of the die to which the cursor has set (in the list).

The window on the right gives a preview of the die to which the cursor has set.

When the available tools are many for a fast choice can be used the scroll bar .

The function buttons have the following meanings:

- **[New Folder]** to create a new folder where save the tools
- **[Find]** to find a tool from the punch or from the die list
- **[New Drawing]** to completely draw the punch or the die
- **[New Type 1]** to use a type 1 pre-set punch or **[New default]** to draw a pre-set die
- **[New Type 2]** to use a type 2 pre-set punch
- **[New Type 3]** to use a type 3 pre-set punch
- **[New Type 4]** to use a type 4 pre-set punch (round punch)
- **[Insert]** to insert the punch or the die selected in the work program or in the selected bend

How to display the preview

Allows you to display the tool preview (to make it easier to identify). The preview function is normally enabled, but can be disabled if not required. Comply with the procedure below:

- Press the  button to access the menu
- Select the **4>> Preview item**
- The preview item is disabled.

Repeat the operation to re-enable the item again.

How to copy a punch or die

This allows you to create a copy of a tool with another name so that it can then be modified. Select the tool you wish to copy with a finger and then comply with the procedure below:

- Press the  button to access the menu
- Select the **[Copy]** item
- This accesses a window where the tool name must be entered.

After the name has been entered, select the **[Ok]** button.

How to rename a punch or die

Allows you to change the name of a tool. Select the tool you wish to rename with a finger and comply with the procedure below:

- press the  button to access the menu
- select the **1>> Rename item**
- this accesses a window where the new tool name must be entered

After the name has been entered, select the **[Ok]** button.

How to erase a punch or die

Allows you to eliminate a tool. Select the tool you wish to eliminate, selecting it with a finger, and comply with the procedure below:

- Press the  button
- Press **[Ok]**
- The selected tool will be erased.

Save all tools on USB

Allows you to save all the tools on USB so that they can then be transferred to another numeric control (useful when must be created backup copies). Comply with the procedure below:

- Insert into the USB port a USB device formatted with enough space to hold the tools.
- Press the  button to access the menu
- Select the **2>> Save Tools**
- All the tools (dies and punches) will be saved on USB.

Erase all tools

Used to erase all the tools. Comply with the procedure below:

- Press the  button to access the menu
- Select the **3>> Delete Tools item.**

All the tools will be Deleted selecting the **[Yes]** button.



Tools list on USB device

Used to display the list of tools USB device. The possible operations are the same as the tool list, then you can copy, rename, and delete all tools present on the USB device. Select the list punches and dies and perform the following steps:

- Insert into the USB port a device containing tools (created by kvara S630 Touch)
- Press the  button.
- The list of punches or dies on USB will be displayed
- Proceed with the required operation.

How to save all tools from USB to NC



Allows you to save the tools from an USB external memory to the internal NC disk, so that they can be downloaded from another numeric control. Comply with the following procedure:

- Insert into the USB port a device containing tools
- Press the  button
- List with punches and dies of the USB device is displayed
- Press the  button to access the menu
- Select the **[Save Tools]** menu.

All the tools (dies and punches) will be saved from the USB external memory to the internal NC disk.

2.1.1 How to enter a new punch

Comply with the following procedure to enter a new punch:

- Press the button  ; the list of punches or list of dies will appear
- If you see the dies list press again the  button.

Select the desired type of punch. The punch can either be completely drawn or three types of pre-set punches with fixed measurements can be used. These measurements are varied in order to rescale and re-design the punch.

The following types of pre-set punch are available:

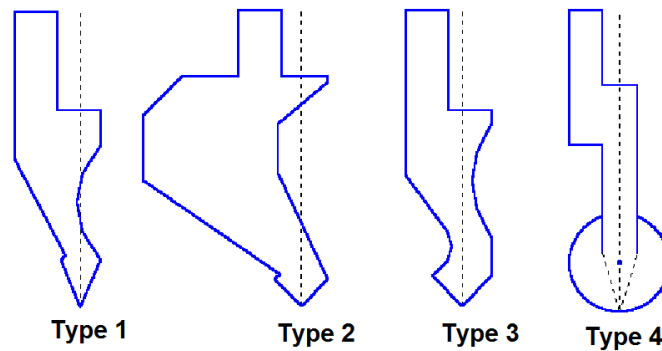

Figure 3 Types of pre-set punch

It is advisable to use pre-set punches if the punch to be entered is similar to one of the proposed types (taken from the catalogues), since the drawing will be less difficult.

The punch must be completely drawn if it is not within the pre-set punch categories.

Note

Remember that the punch drawing is used to make anti-collision checks for the graphically designed work pieces, while the bending depth calculation is developed according to the punch dimension data. If there are difficulties in completely drawing a punch, the problem can be obviated by using a type of pre-set punch and attempting to adapt it to the real shape as much as possible by means of the pre-defined data.

- Press
- **[New Drawing]** to completely design the punch;
- **[New Type 1]** to use a pre-set punch type 1;
- **[New Type 2]** to use a pre-set punch type 2;
- **[New Type 3]** to use a pre-set punch type 3.
- **[New Type 4]** to use a type 4 pre-set punch (round punch).

A window will be opened requesting entry of the punch dimensions:

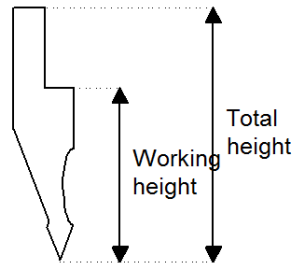

Figure 4 Punch dimensions

Enter the total height and working height as indicated in the figure.

Access to the drawing page

Access the drawing page once the punch dimensions have been entered and the type of punch selected.

The drawing page changes, depending on the type of punch selected:

- Select the **[OK]** button.

2.1.2 Punches to draw

The punches to draw page is obtained by means of the drawing function (see relative chapter of this manual).

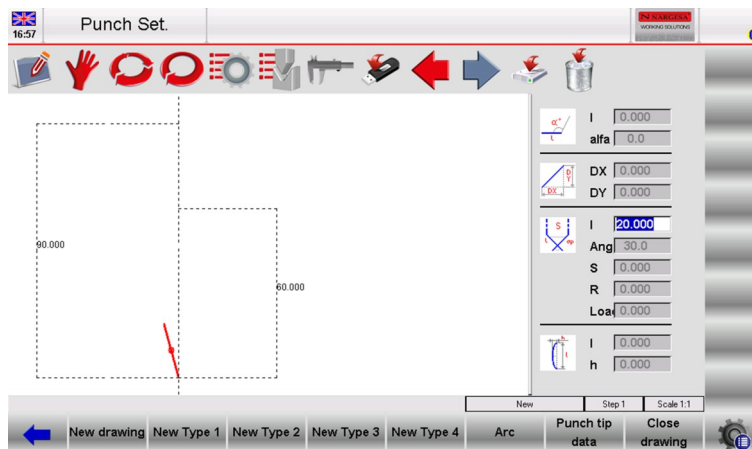

Figure 5 Punch drawing page

The left-hand window is the drawing window.

The four right-hand windows are drawing data entry windows and respectively represent:

- The polar drawing data
- The Cartesian drawing data
- The vertex drawing data
- The arc drawing data

Drawing conventions

The punch must be drawn in an anticlockwise direction, remembering that the back-gauges are on the right-hand side of the punch itself.

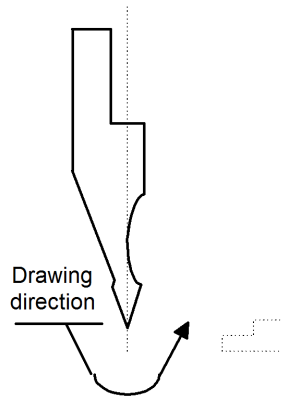

Figure 6 Punch drawing direction

Vertex entry

The tip must be defined in order to use the punch drawing. When the drawing is started, the marked line represents one of the two sides of the tip. Proceed in the following way to define the tip:

- Enter the length "lp", touching with a finger on the field;
- Press **[Ok]**;
- Enter the tip angle (ang. angle), touching with a finger on the field;
- Press **[Ok]**;
- Enter the tip chamfer if the tip is flat, touching with a finger on the field (S data item, normally is 0)
- Press **[Ok]**;
- Enter the tip radius (R data item), touching with a finger on the field;
- Press **[Ok]**;
- Enter the punch load (maximum tons for meter), touching with a finger on the field;
- Press **[Ok]**.

The tip will be drawn and the next length will be automatically drawn with a default length of 20 mm.

How to do the drawing

Supposing that the following punch must be drawn:

The cursor is in Field 1 of the data entry window of the drawn tip data:

- Enter the tip data as previously described
- Enter the length of the second side of the tip (section I1)
- Press **[ENTER]**: the cursor will set to the **alpha** Field where the angle is entered in relation to the next section
- Press on the display to move to the design, using own touch (touch environment)
- Press **[ENTER]**: the next section will be drawn in automatic mode. The section to which the data refer will be marked, the cursor will move to Field 1 where the length of the section is entered
- Press **[Arc]**
- Enter the length corresponding to section I2 in Field 1
- Enter the depth corresponding to section p1 in Field h
- Press **[ENTER]**
- Enter the length corresponding to section I3 in Field 1
- Press **[ENTER]**: the cursor will move to the **alpha** Field where the angle is entered in relation to the next section
- Enter value 90.0 in the **alpha** field
- Press **[ENTER]**: the next section will be drawn in automatic mode. The section to which the data refer will be marked, the cursor will move to Field 1 where the section length can be entered. The punch drawing will form by continuing to alternatively enter the lengths and angles. The more the entered measurements and angles correspond to reality, the more the drawing will be correct. Figure 7 Example of a punch to be drawn.

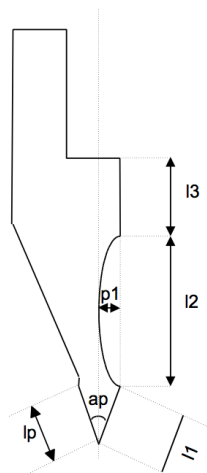



Figure 7) Example of punch draw

Graphic helps

In relation to sections whose measurements may cause difficulties, the operator can use graphic helps allowing the angle value to be varied by $\pm 1^\circ$ and the length to be varied by $\pm 1\text{mm}$ each time. This achieves a visual correspondence between the drawing and the real punch. To enable this feature, only valid for settings punches:

- Press the  button to access the menu
- Select the **3>> DYNAMIC**

The angle value is increased by 1° by pressing the right arrow and is diminished by one degree at a time by pressing the left arrow. The length value is increased by pressing the up arrow and decreased by pressing the down arrow.



Drawing curved sections



As shown in the example, the drawing function can be used to draw curved sections. Press the [Arc] key and the cursor will move to the arc data entry window.

Enter length "l" and depth "h" of the arc and the curve corresponding to the entered data will be automatically plotted.

Entered data correction

Incorrect entries may be made during drawing entry.

Is it possible correct these entries moving amongst the various drawn with the  and  buttons and by modifying the values of the fields.

- Use the  button to switch to the immediately previous entry field and then alternatively pass to a length entry field "l" and an angle entry field "alpha".
- The  button immediately passes to the next length and, thus, always to the length entry Field "l"
- Press **[ENTER]** to pass to the immediately following entry Field and to then alternatively pass to a section entry Field (l) and an angle entry Field (alpha).

Error correction

A very frequent error (particularly if the arrows are used to enter the angles) is that of forgetting to press **[ENTER]** after having entered an angle. At this point, the length of the section will be entered in the angle entry field, thus creating an error in the drawing.

Use the key  to move back to the angle entry Field and re-enter the correct value.

Saving the drawing

At the end of the drawing, press the  button to save it in the internal memory. Enter the name of the punch in the window that appears, touching with a finger on the field.

After the name has been entered, select the **[Ok]** button.

Tolerated name characters

The entered name can be formed by a combination of numbers and letters (e.g. can be used the code of the punch of the catalogue).

2.1.3. Pre-set punches

The pre-set punch page is presented in the form of a pre-drawn punch along with a series of data that characterize the shape of that punch.

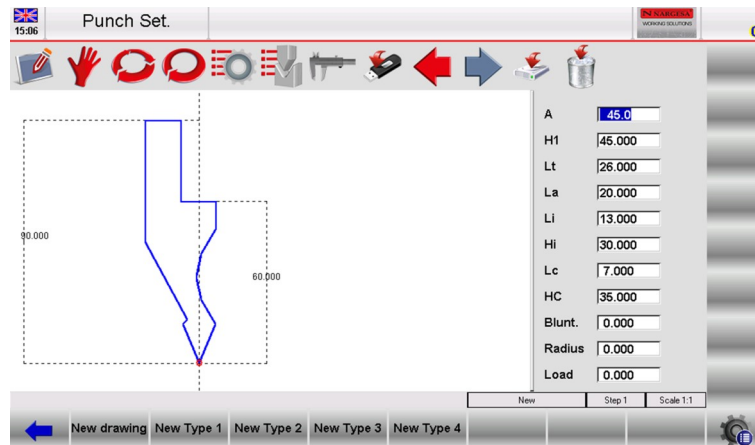



Figure 8) Preset punch

When the data are scrolled with the arrows or **[ENTER]** key, a red indication will appear on the drawing as to which measurement corresponds to the selected data item.

By modifying any one of the values and pressing **[ENTER]**, the drawing will be re-plotted by taking the modified value into account.

Saving the drawing

At the end of the drawing, press the  button to save it in the internal memory. Enter the name of the punch in the window that appears, touching with a finger on the field.



After the name has been entered, select the **[OK]** button.

Tolerated name characters

The entered name can be formed by a combination of numbers and letters (e.g. can be used the code of the punch of the catalogue).

2.2 How to enter a new die

Comply with the following procedure to enter a new die:

- Press the  button; the list of punches or list of dies will appear.
- If the list of punches appears, press  button again.
- Select the required type of die. The die can be completely drawn or the pre-set die with fixed dimensions can be used. These measurements can be varied in order to rescale and redraw the die:

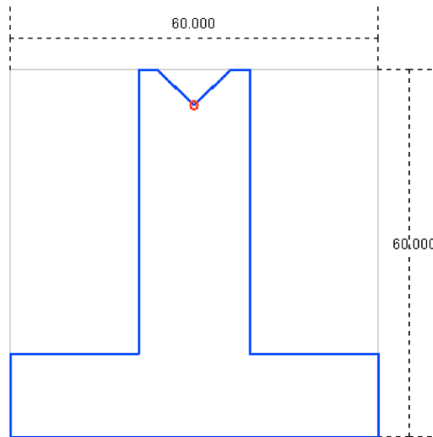

Figure 9 Available types of pre-set die

It is advisable to use pre-set dies if the die to be entered is similar to one of the proposed types (both square and overturned T dies can be drawn), since the drawing will be less difficult.

The die must be completely drawn if it is not within the pre-set die categories, if is a die with several V-die, if is a square V-die or a dutch folding die.

Note

Remember that the die drawing is used to make anti-collision checks for the graphically designed work pieces, while the bending depth calculation is developed according to the die dimension data. If there are difficulties in completely drawing a die, the problem can be obviated by using a type of pre-set die and attempting to adapt it to the real shape as much as possible by means of the pre-defined data:

Press:

- **[New drawing]** to completely design the die;
- **[New default]** to use the data of the pre-set die.

A window will be opened requesting entry of the die dimensions:

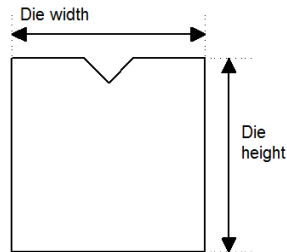

Figure 10 Die dimensions

Enter the die width and the die height as indicated in Figure 10 selecting with a finger the fields “width” and “height”.

Access to the drawing page

Access at the drawing page once the die dimensions have been entered and the type of die selected. The drawing page changes, depending on the type of die selected:

Select the **[Ok]** button.

2.2.1 Dies to draw

The dies to draw page is obtained by means of the drawing function (see relative chapter in the operator manual).

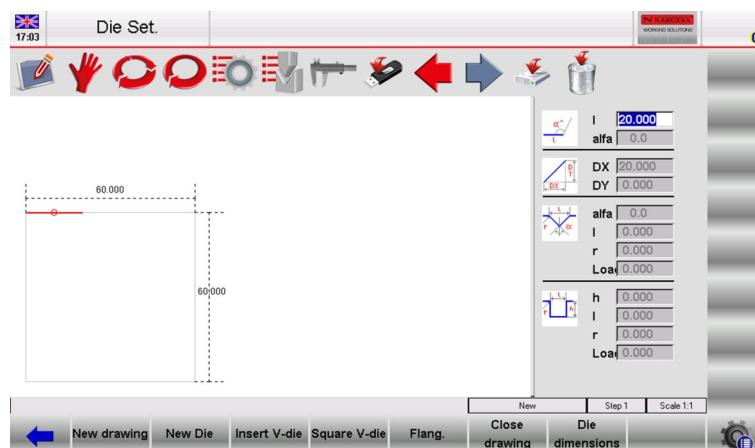

Figure 11 Die drawing page

The left-hand window is the drawing window.

The four right-hand windows are drawing data entry windows and respectively represent:

- 1) The polar drawing data;
- 2) The Cartesian drawing data;
- 3) The V-die drawing data;
- 4) The square die drawing data.

Drawing conventions

The die must be drawn in a clockwise direction, remembering that the back-gauges are on the right-hand side of the die.

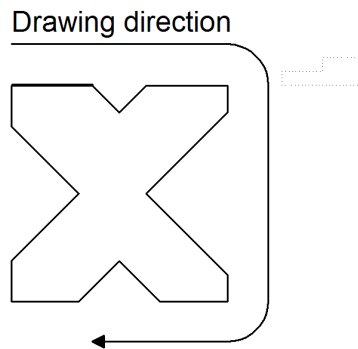

Figure 12 Die drawing direction

The marked line represents the line initially proposed in the drawing page.

How to do the drawing

Supposing that the following die must be drawn:

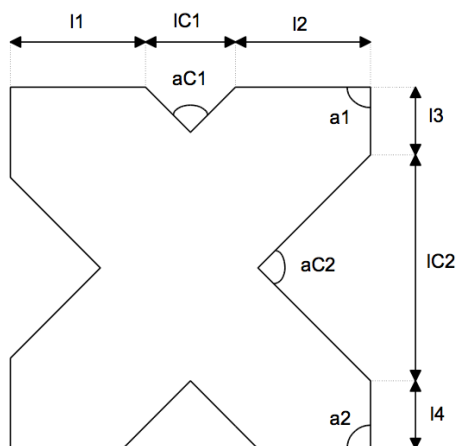

Figure 13 Example of a die to be drawn

The cursor is in Field 1 of the polar drawing data entry window:

- Enter the length corresponding to the length **I1** in the field "l", touching with a finger on the field;
- Press **[OK]**: the cursor will set to the α Field where the angle is entered in relation to the next section. Now define the first V-die of the die.

V-die entry

Comply with the following procedure:

- Press **[Insert V-die]**; the data entry window will automatically switch to the V-die data where it is necessary to:
- Enter the V-die angle (angle $\alpha C1$), touching with a finger on the field;
- Press **[OK]**;
- Enter the width "l" of the V-die (IC1 length), touching with a finger on the field ;
- Press **[OK]**;
- Enter radius R of the V-die, touching with a finger on the field;
- Press **[OK]**;
- Enter the V-die load (maximum tons for meter), touching with a finger on the field;
- Press **[OK]**; the V-die will be drawn and the next length automatically entered. The cursor will return to the polar data entry window;
- Enter the length corresponding to section I2 in field "l", touching with a finger on the field;
- Press **[OK]**;
- Enter the value of angle $\alpha 1$, touching with a finger on the field;
- Press **[OK]**; the next length will be drawn in automatic mode. The length to which the data refer will be marked, the cursor will move to the field "l";
- Enter the length corresponding to the length I3 in the field "l", touching with a finger on the field;
- Press **[OK]**; the cursor will move to the α field where the angle is entered in relation to the next length.

The second V-die must now be defined:



- Press **[Insert V-die]**; the data entry window will automatically switch to the V-die data where it is necessary to:
- Enter the V-die angle (angle $\alpha C2$), touching with a finger on the field;
- Press **[OK]**;
- Enter length "l" of the V-die (section IC2), touching with a finger on the field;
- Press **[OK]**;
- Enter the V-die radius R, touching with a finger on the field;
- Press **[OK]**;
- Enter the V-die load (maximum tons for meter), touching with a finger on the field;
- Press **[OK]**; the V-die will be drawn and the next length automatically entered. The cursor will return to the polar data entry window;
- Enter the length corresponding to the length I4 in the field "l", touching with a finger on the field;



- Press **[Ok]**;
- Enter the value of the angle a_2 , touching with a finger on the field;
- Press **[Ok]**.

The die drawing will form by continuing to alternatively enter the lengths and angles. More the entered measurements and angles correspond to reality, more the drawing will be correct.

Entered data correction

Incorrect entries may be made during drawing entry.

Is it possible correct these entries moving amongst the various drawn with the  and  buttons and by modifying the values of the fields.

- Use the  button to switch to the immediately previous entry field and then alternatively pass to a length entry field "l" and an angle entry field "alpha".
- The  button immediately passes to the next length and, thus, always to the length entry Field "l"

Square V-die entry

The die drawing page can be used to enter square V-die. To enter one of these, execute the following operations when on angle entry Field α of the length prior to the V-die:

- Press **[Square V-die]**.

This accesses the square V-die data entry window.

- Enter the depth "h" of the V-die, touching with a finger on the field;
- Press **[Ok]**;
- Enter the width "l" of the V-die, touching with a finger on the field;
- Press **[Ok]**;
- Enter radius "r" of the V-die, touching with a finger on the field;
- Press **[Ok]**;
- Enter the V-die "load" (maximum tons for meter) , touching with a finger on the field;
- Press **[Ok]**; the square V-die will be drawn with the entered data. The cursor will return to the polar data description window in order to describe the next die length.

Square V-die conventions

If a square V-die has been entered, the minimum bend angle that can be made is the angle corresponding to a V-die of the entered width and depth.

Dutch folding V-die entry (hemming V-die)

The die drawing page can be used to enter Dutch folding V-die. To define one of these, it is necessary to indicate which are the lengths that determine the die closing by their movement and then draw a length squashed on both sides.

- Draw the profile of the open die with the recess of the flattening part;
- Move the selection to the line to be defined like Dutch folding (vertical length);
- Press **[Flang.]**.
- The line defined as the flattening part will appear hatched on the drawing.

The following figure shows an example of the bending Dutch folding die.

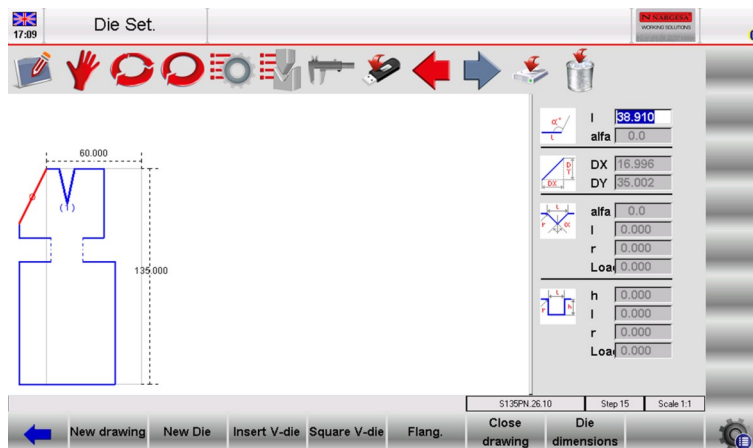

Figure 14 Drawing of the Dutch folding die

How to enter Dutch folding pneumatic die

The die drawing page can be used to enter Dutch folding pneumatics dies.

To define one, two flattening 0.001 mm length lines must be indicated on both sides of the die.

- Draw the profile of the open die with the recess of the flattening part, but enter 0.001 mm for the flattening lines (as though the die were closed);
- Move the selection to the line to be defined like Dutch folding (vertical length);
- Press **[Flang.]**;
- The line defined as the flattening part will appear hatched in the drawing;
- Once the die has been drawn, press **[Die dimensions]** and digitize 1 in the “Pneumatic (1=yes 0=no)” field;
- Select the **[Ok]** button;
- From this moment onwards, function 2 will be automatically enabled on the Dutch Folding bends.

When the bend is flattened with a pneumatic die, the die will open and will then drop in the fast mode with the ram: the tools could touch each other during the ram fast down phase (something to be avoided). For this reason the ram must change speed first (at a higher target). To do this is needed to change the “mute-point” of the bend

Entry of the pneumatic flattening die support

If the press has a pneumatic flattening die support, the relative data can be entered in the General Parameters Configuration page (refer to the machine parameters manual). Once the data have been entered, flattened bends can also be obtained in the graphic mode using standard dies without having to draw particular dies with bending-flattening functions.

Saving the drawing

At the end of the drawing, press the  button to save it in the internal memory.

Enter the name of the die in the window that appears.

After the name has been entered, select the **[OK]** button.

Tolerated name characters

The entered name can be formed by a combination of numbers and letters (e.g. can be used the code of the die of the catalogue).

2.2.2. Pre-set dies

The pre-set die page is presented in the form of a pre-drawn die along with a series of data that characterize the shape of that die.

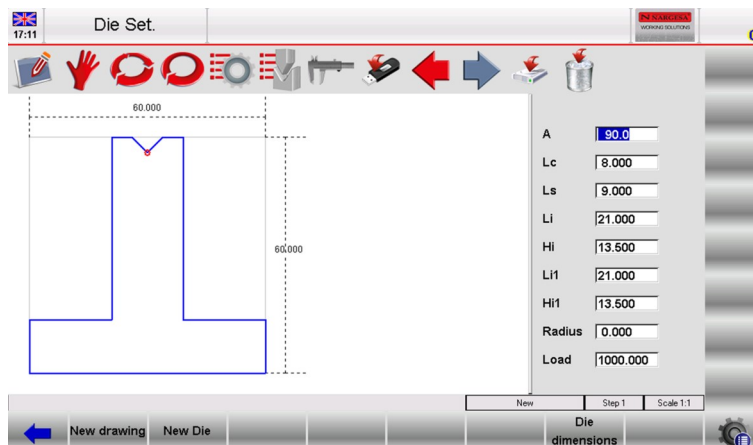

Figure 15 Pre-set die

By modifying any one of the values and pressing **[OK]**, the drawing will be re-plotted by taking the modified value into account.

Saving the drawing

At the end of the drawing, press the  button to save it in the internal memory.

Enter the name of the die in the window that appears, touching with a finger on the field.

After the name has been entered, select the **[OK]** button.

3. PROGRAMMING

3.1. List of programs

To enter the list of programs it is necessary to follow the steps below:

- Press 
- The following window will appear:

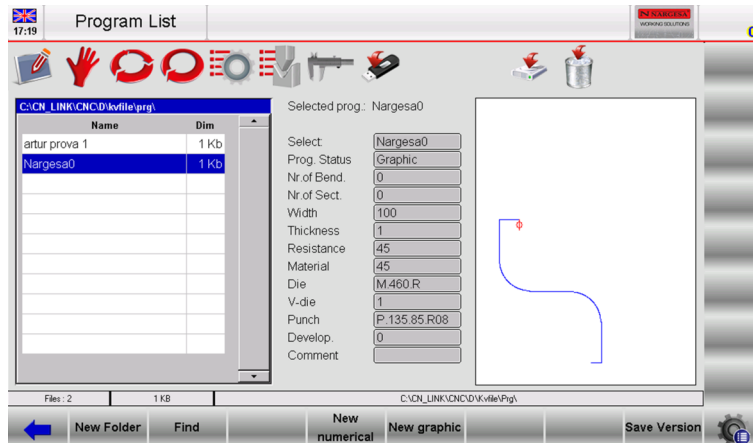

Figure 16 List of programs

The window on the left is the program list.

The central boxes contain the program data on which the cursor is positioned (on the list).

The window on the right shows a preview of the program on which the cursor is found.

To scroll down the programs available on the list just use the scroll bar.

The function keys displayed have the following meanings:

- **[New Folder]** to create a new folder where save the programs.
- **[Find]** to find a program in the list window.
- **[New Numerical]** to set a new numeric program.
- **[New Graphic]** to set a new graphic program.
- **[Save Version]** to save the programs in a previous version.

How to view the Preview

This allows you to see the preview of the program (if the program is graphic). The preview is normally enabled but if desired you can also disable it by following the steps below:

- Press the  button to open the menu.
- Select the item **4>> Preview**.
- The preview window will be disabled.
- To re-enable it just repeat the steps above.

How to copy a program

This allows you to create a copy of a program with another name so that you can change it. Move onto the program you wish to copy selecting it with a finger and follow the steps below:

- Press the  button to open the menu.
- Select the item **0>> Copy**.
- A window will open in which it will be necessary to enter the name of the program, touching with a finger on the field.
- After entering the name, move onto the **[Ok]** button.

Renaming a program

This allows you to change the name of a program. Move onto the program you wish to rename selecting it with a finger and follow the steps below:

- Press the  button to open the menu.
- Select the item **1>> Rename**.
- A window will open in which it will be necessary to enter the new name of the program.
- After having entered the name move onto the **[Ok]** button.

Saving a program

This allows you to save a program on the USB device in order to then transfer it to another control (also useful for creating backup copies). Move onto the program you wish to save selecting it with a finger and follow the steps below:

- Press the  button.
- The program selected will be saved on the USB device.

Deleting a program

This allows you to delete a program. Move onto the program you wish to delete selecting it with a finger and follow the steps below:

- Press the  button.
- Press the **[Yes]** button.
- The selected program will be deleted.

Saving all the programs on the USB device

This allows you to save the programs on the USB device in order to then transfer them to another control (this also allows you to create backup copies). Follow the steps below:

Insert a fat32 USB formatted device with enough space for containing the programs into the USB port:

- Press the  button to open the menu.
- Select the item **2>> Save programs**.
- All the programs will be saved on the USB device.

Deleting all the programs

This allows you to delete all the programs. Follow the steps below:

- Press the  button to open the menu.
- Select the item **3>> Delete programs**.
- All the programs will be deleted (you will be asked the confirm).

Programs list on the USB device

This allows you to view the program list on the USB device. The possible operations are the same as for the tool list therefore it is possible to copy, rename and delete all the tools present on the USB device.

Select the program list and follow the steps below:

Insert the USB device containing the programs into the USB port.

- Press the  button.
- The programs list on the USB device will be displayed.
- Execute the desired operation.



Saving a program from a USB device to NC

This allows you to save a program on NC from a USB device in order to be able to download it from another control. Select the program you wish to save with a finger and follow the steps below:

- Press the  button;
- The program selected will be saved from the USB device to NC.



Saving all the programs from a USB device to NC

This allows you to save the programs on NC from a USB device in order to be able to download them from another control. Follow the steps below:

- Insert a USB device containing the programs into the USB port.
- Press the  button. The programs list on the USB device will be displayed
- Press the  button to open the menu.
- Select the item **2>> Save programs**.
- All the programs will be saved from the USB device to NC.

Changing the work unit

This operation can be performed in the following sequence:

- Press the  button to open the Program list
- Press the  button to open the menu
- Press **5 >> Change work drive**.
- Select with a finger a work drive from the list

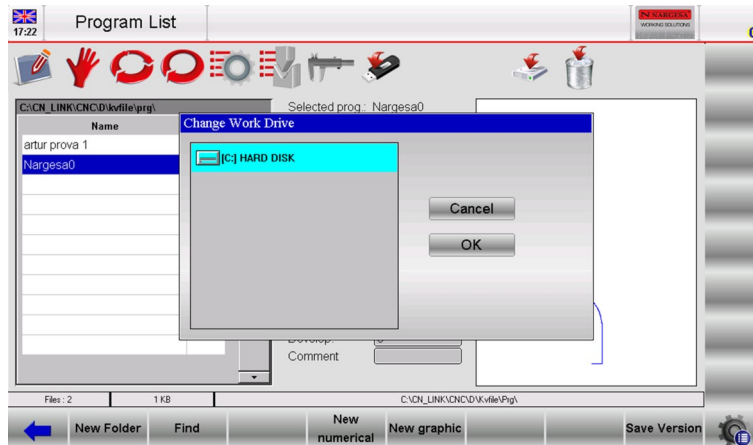

Figure 17 View of the operation for changing the work unit.

3.2. Entering a numeric program

To enter a new numeric program press [New Programm] from the Editor page of a numerical program and select **[New numerical]**:



Figure 18 New numerical program

Or it can be create from the program list pressing  and **[New numerical]**.

Setting the piece data

A window will open for entering the program data:

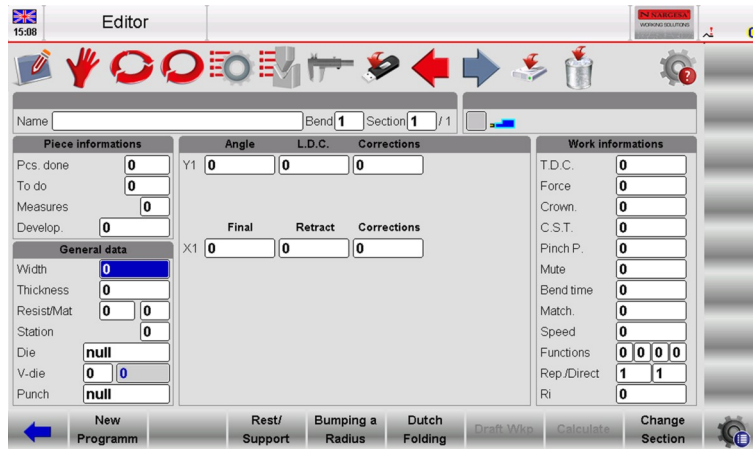

Figure 19 Page for entering the bends

- Enter the width of the metal sheet to be bent, touching with a finger on the field and selecting **[Ok]**.
- Enter the thickness of the metal sheet to be bent, touching with a finger on the field and selecting **[Ok]**.
- Enter the resistance of the metal sheet to be bent considering that:

To bend ALUMINIUM set values from 0 to 30

To bend IRON set values from 31 to 50

To bend STAINLESS STEEL set values greater than 50

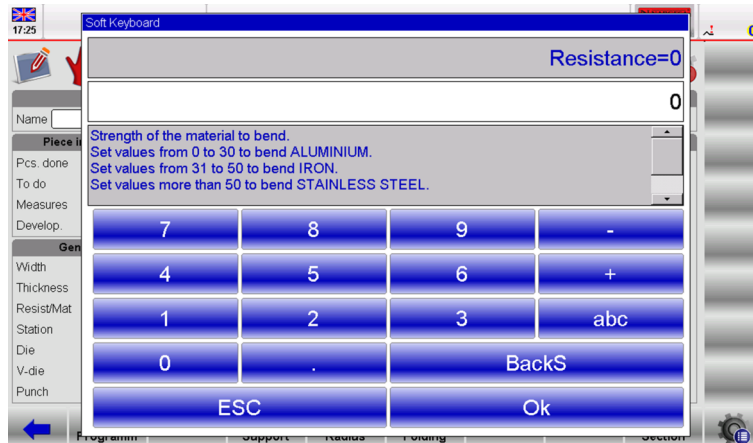

Figure 20 help page of the material resistance built-in the Soft Keyboard

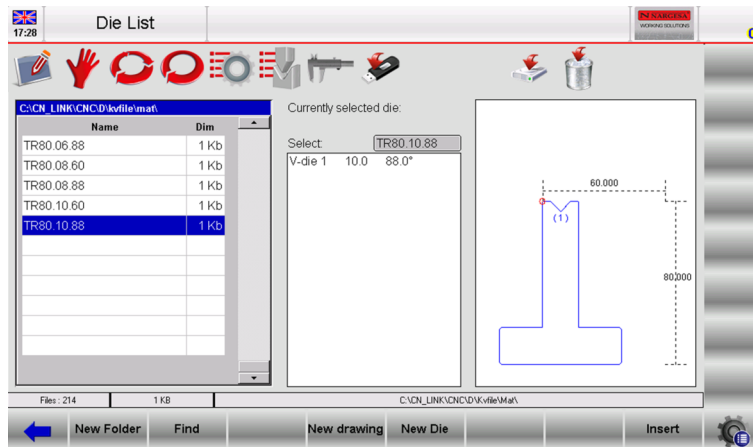

Figure 21 Die list page, example of die insertion

- The **material** is calculated automatically depending on the resistance.
- Enter the **work** station if more than one or if they are defined, otherwise leave 0.
- Enter the **die** that will be used from the list touching with a finger on the field, scrolling the toolbar in order to choose the die and pressing the button **[Insert]** (the die must already have been drawn), like showed in the figure 21.
- Enter the **V-die** of the die that will be used for the bend, touching with a finger on the field and selecting **[Ok]** (a die can have more than one V-die; in the event of only having one, enter 1). To the right appears the width of the V-die selected.
- Enter the **punch** that will be used from the list touching with a finger on the field, scrolling the toolbar in order to choose the punch and pressing the button **[Insert]** (the punch must already have been drawn).

Setting the bends

The cursor now moves into the fields for setting the bend.

Set for each bend:

- The desired bend angle in the **Y1 Angle** field.
- The desired bend length in the Field **Final X1** field.

All the other data relating to the bend will be calculated automatically but they can still be changed by the user.

Work data

This allows you to view the data relating to the absolute T.D.C, Mute and Pinch Point of that bend, move onto the desired bend and follow the steps below:

- Press the  button to open the menu.
- Select the item **7>> Work Information**.
- A window will appear which contains the work data.
- For exit just move onto the **[Ok]** button.

Copying a bend

To copy a bend, move onto the bend you wish to copy and follow the steps below:

- Press the  button to open the menu.
- Select the item **5>> Copy step**; the bend will be copied at the end of the section.





Entering a bend

To enter a bend in a section, move onto the bend after the one you wish to enter and follow the steps below:

- Press the  button to open the menu.
- Select the item **4>> insert step**; the bend will be inserted before the one you moved onto.

Entering a copied bend

To enter an identical bend to the one already present in the section, move onto the bend after the one you wish to enter and follow the steps below:

- Press the  button to open the menu.
- Select the item **4>> Insert step** for insert a new bend before the selected bend.
- With the  or  buttons move into the bend you wish to copy
- Press the  button to open the menu.
- Select the item **5>> Copy step** ; the bend will be copied on the one you have just entered.

Defining a radius bend

In the window for entering the data of the numeric program it is possible to activate help for creating a radius bend:

- Press [Bumping a Radius]; a window will open to enter the data of the radius bend.
- Enter the desired rolling angle in the “Angle” field, touching with a finger on the field and selecting **[Ok]**.
- Enter the rolling radius in the “Radius” field, touching with a finger on the field and selecting **[Ok]**.
- Enter the length of the rolling pitch in the “Length” field, touching with a finger on the field and selecting **[Ok]**.
- Enter the initial position of the stop in the “X posit.” field, touching with a finger on the field and selecting **[Ok]**.
- Select the [Confirm] key, the rolling bends calculated will be automatically entered on the bend Editor page.

Correcting a radius bend

Whenever a radius bend is realized it is unlikely that you will obtain a correct bend at first try: this imprecision depends on the fact that the angles that have to be bent to create the rolling are opened too far (e.g.: 170°) and it is difficult to obtain correct bends with these angles.

In order to obtain a correct rolling it is necessary to measure the difference between the angle of the radius obtained and the desired angle: the difference calculated must be divided equally on all the bends.

Example

Let's suppose we have to create a rolling with an angle of 90° in which it is necessary to make 15 bends equal to 170°; if the rolling obtained is 112.5° we must perform the following:

$112.5 - 90 = 22.5^\circ$ (difference between the real and the theoretical angles)

$22.5 / 15 = 1.5^\circ$ (correction to be applied for each bend)

We must apply a correction of 1.5° in the rolling pitch which will be repeated 15 times.

Definition of a Dutch folding (or hemming bend)

In the window for setting the bends it is possible to define a Dutch folding bend:

enter 0.0 in the Y1 angle field, and the arrival value of the ram will be calculated by keeping account of the depth of the V-die, the height of the V-die for hemming and the thickness of the piece; the position of the axis X is set at the minimum height reachable by the axis; the R axis is positioned by bearing in mind that the die is open.

For ensuring greater work programming speed a Dutch folding can be defined by directly entering the Editor page and pressing the [Dutch Folding] function.

Correcting a Dutch folding

To correct a Dutch folding it is not possible to change the value of the angle, but it is necessary to change the numeric value present in the Field L.D.C. of Y1.

If the bend is hemmed too much it will be necessary to increase this value.

The Height Y2 will subsequently be changed.

Otherwise it will be necessary to:

- Enter in the Corrections page by pressing 

- Press the **[Coeff. corrections]** key

- The data entered in the Dutch folding field will be directly added or subtracted from the L.D.C. of both the Y. This value is linked to the machine and not to the program. To cancel the correction press the key **[Undo correct.]**.

3.3 Entering a graphic program (Optional in the S630 model)

To enter a new graphic program press **[New Programm]** from the Editor page of a numerical program and select **[New graphic]**:

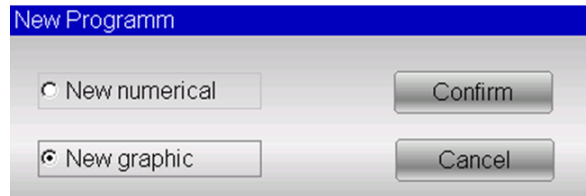



Figure 24 New Graphic program

Or it can be create from the program list pressing  and **[New graphic]** .

Setting of the general data

A window will open to enter the general data of the program.

If these data are not entered, access will not be permitted to the drawing function:

- Enter the **width** of the metal sheet to be bent, touching with a finger on the field and selecting **[Ok]**.
- Enter the **thickness** of the metal sheet to be bent, touching with a finger on the field and selecting **[Ok]**.
- Enter the **resistance** of the material to be bent, touching with a finger on the field and selecting **[Ok]**, like described in the chapter 3.2
- The **material** is calculated automatically depending of its resistance.
- Enter the **work station** if more than one or if they are defined, otherwise leave 0
- Enter the **die** that will be used from the list touching with a finger on the field, scrolling the toolbar in order to choose the die and pressing the button **[Insert]** (the die must already have been drawn).
- Enter the **V-die** of the die that will be used for the bend, touching with a finger on the field and selecting **[Ok]** (a die can have more than one V-die; in the event of only having one, enter 1).
- Enter the **Die Orient. (0 = standard, 1 = rotated by 180°)**.
- Enter the punch that will be used from the list touching with a finger on the field, scrolling the toolbar in order to choose the punch and pressing the button **[Insert]** (the punch must already have been drawn).
- Enter the Punch **Orient (0 = standard, 1 = rotated by 180°)**.
- Enter a **Comment** if desired.
- Enter the **measures** parameter desired.
- Select the **[Ok]** button.

Drawing window

The drawing window page will be opened.

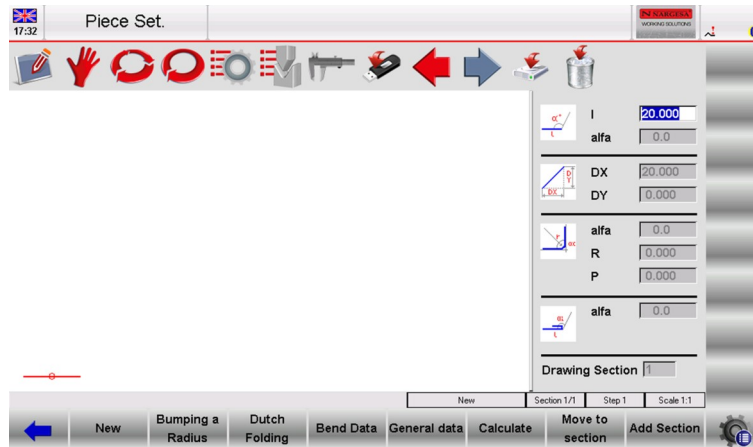

Figure 25 Drawing page of the piece.

The window on the left is the drawing window. The four windows on the right are for entering the drawing data and they respectively represent:

- 1) The polar drawing data.
- 2) The Cartesian drawing data (normally not used).
- 3) The drawing data of a Radius bends.
- 4) The drawing data of a Dutch folding bends (hemming).

After having entered the general data and accessed *the Piece Set* page, the first segment will appear in red with a length of 20.0 mm. Touching with a finger the field "l" a "Soft Keyboard" will open, as in Figure 26

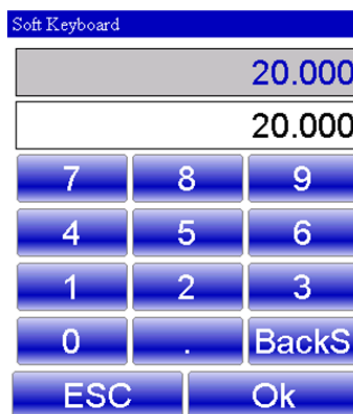

Figure 26 Soft Keyboard for setting the length of the piece

- With which you can change the length of the first segment by entering a value different from 20.
- After having pressed "OK" automatically you move to the next field, the "alfa" polar drawing data. Pressing with a finger on this field the angles "Soft Keyboard" appears, like showed in figure 27

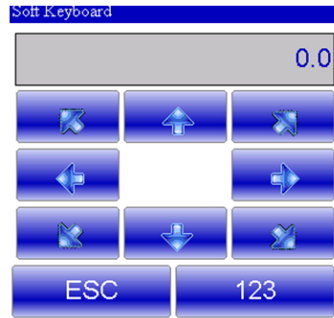



Figure 27 Soft Keyboard for setting the angle of the piece

- By touching one of the height arrows starting from this  in the clockwise direction, the next segment will be taken to different predefined angles, that is 45, 90, 135, 180, -135,-90, -45. Pressing the soft-key  is possible introduce angles different from the predefined, like showed in figure 28

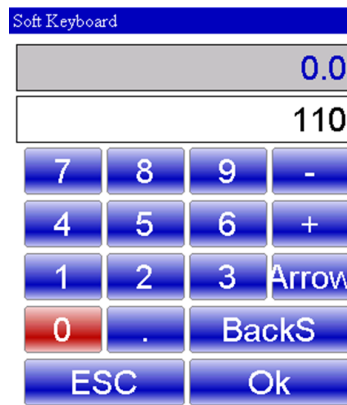

Figure 28 Soft Keyboard for setting not predefined angle of the piece

- After have set the angle automatically we go to the polar drawing field of the next length “l”, where touching with a finger the soft keyboard for setting the length of the piece open, in order to continue the piece drawing like shown in the figure 29

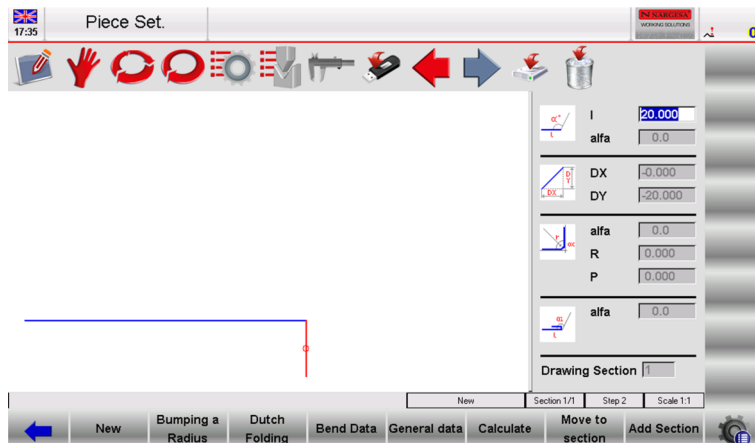





Figure 29 length setting of the second bend

Bend sequencing

This allows you to view the sequence via which the piece must be bent. Follow the steps below:

- From the AUTOMATIC graphic page press the  button to open the menu.
- Select the item **0>> Bending sequence**.
- Move among the various bends by pressing the  and  buttons.



Change color

This allows you to change the color of the background of the piece to bend.

- From the AUTOMATIC graphic page press the  button to open the menu.
- Select the item **1>> Change color**.

3D Viewer (Optional in the S630 model)

This allows you to view the drawing in 3D. Follow the steps below:

- From the AUTOMATIC graphic page press the  button to open the menu.
- Select the item **3>> 3D Viewer**.
- To return to the 2D view press the  button.

How to realize the drawing of a piece

Let's suppose we have to draw the piece illustrated in the figure below:

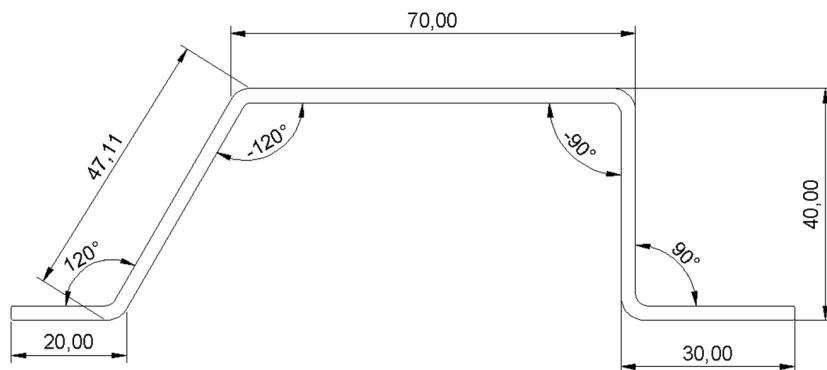

Figure 30 Example of piece to be drawn (external measures)

The cursor is located in the field "l" of the window for the polar setting of the drawing data:

- Enter in the field "l", the length corresponding to the first section of the piece to be drawn (20.0).
- Press **[Ok]**.
- Enter the value of the first angle (120.0°) in the field "alfa" (value of the angle compared to the following length).
- Press **[Ok]**, the next length will be drawn in automatic mode; the length that the data refer to will be highlighted.
- Enter the length in the field "l" corresponding to the second length of the piece to be drawn (47.11).
- Press **[Ok]**.

- Enter the value of the second angle (-120.0°) in the field “alfa” (value of the angle compared to the following length).
- Press **[Ok]**, the next length will be drawn in automatic mode; the length that the data refer to will be highlighted.
- Enter the length in the field “l” corresponding to the third length of the piece to be drawn (70.0) .
- Press **[Ok]**.
- Enter the value of the third angle (-90.0°) in the Field “alfa” (value of the angle compared to the following length).
- Press **[Ok]**, the next length will be drawn in automatic mode; the length that the data refer to will be highlighted.
- Enter the length in the field “l” corresponding to the fourth section of the piece to be drawn (40.0).
- Press **[Ok]**.
- Enter the value of the fourth angle (90.0°) in Field “alfa” (value of the angle compared to the following length).
- Press **[Ok]**, the next length will be drawn in automatic mode; the length that the data refer to will be highlighted.
- Enter the length in the field “l” corresponding to the fifth length of the piece to be drawn (30.0).
- Press **[Ok]**, the drawing has now been completed.

How to realize a radius bend

In order to realize a radius bend it is necessary to bear in mind that as per the convention, there must be a length of metal sheet before and after the radius.

Let's suppose we have to draw the piece illustrated in the figure below:

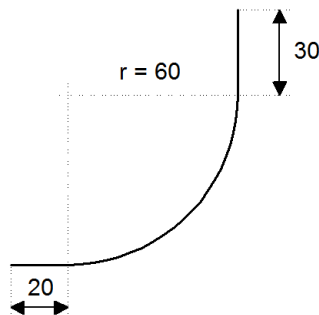

Figure 31 Example of a radius to be drawn

The cursor is located in the field “l” of the window for the polar setting of the drawing data:

- Enter the length corresponding to the first length of the piece to be drawn (20.0) in the Field “l”.
- Press **[Ok]**.
- Press **[Bumping a Radius]**; the window of the radius data will open.
- Enter the desired rolling angle (90.0°) in the field “alfa”, touching with a finger on the field.
- Press **[Ok]**.

- Enter the radius of the rolling (60.0) in the field “R”, touching with a finger on the field.
- Press **[OK]**.
- Enter the length of the rolling pitch you want to obtain in the field “P”, touching with a finger on the field.
- Press **[OK]**, the next length will be drawn in automatic mode; the length that the data refer to will be highlighted.
- Enter the length corresponding to the last length to be drawn (30.0) in the field “I” , touching with a finger on the field.
- Press **[OK]**, the drawing has now been completed.

How to execute a Dutch Folding (hemming)

Let's suppose we have to draw the piece illustrated in the figure 32:

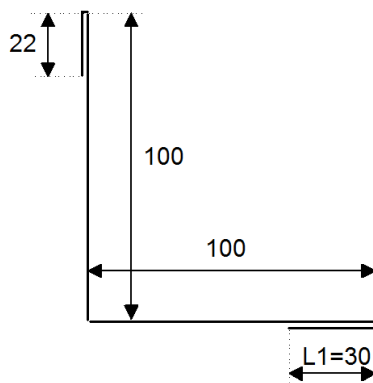



Figure 32 Example of Dutch Folding bend to be drawn

The cursor is located in the field “I” of the window for the polar setting of the drawing data.

- Enter the length of side L1 to be hemmed (30.0) in the field “I” , touching with a finger on the field.
- Press **[OK]**.
- Press **[Dutch Folding]**.
- Enter the intermediate Dutch folding angle (e.g.: 45.0°) in the “*alfa*” field, touching with a finger on the field.
- Press **[OK]**, the next length will be drawn in automatic mode; the length the data refer to will be highlighted.
- Enter the length of the side (100.0) in the field “I”, touching with a finger on the field.
- Press **[OK]**, the cursor will move onto the field “*alfa*” for setting the angle compared to the following length.
- Enter the value of the angle (-90.0°), touching with a finger on the field.
- Press **[OK]**, Enter the length of the side (100.0) in the field “I”, touching with a finger on the field .
- Press **[OK]**.
- Press **[Dutch Folding]**.
- Enter the intermediate Dutch folding angle (e.g.: 45.0°) in the *alfa* field, touching with a finger on the field.
- Press **[OK]**, the next length will be drawn in automatic mode; the length the data refer to will be highlighted.
- Enter the length of the last side (22.0) in the field “I”, touching with a finger on the field. The drawing has now been completed.

Saving the drawing

At the end of the setting, press the  button; a window will open in which it is necessary to enter the name of the program.

After having entered the name, touching with a finger on the field, move onto the [Ok] button.

 **3.4 Automatic calculation of the bending sequence (Optional in the S630 model)**



It is possible to access the automatic calculation procedure from the drawing page of the piece by following the steps below:

- From the PIECE SETTING page after have drawing it in all its parts press **[Calculate]**.

Calculation window

A window will open that shows the simulation of the piece to be bent, including the lower and upper part of the press-brake, the punch, the die, the stops and the piece before to being bent.

On the right side of the page there are three windows that respectively indicate the upsetting and the number of rotations of the piece relating to the bending sequence found, and the criterion chosen for the bending sequence search (Criterion).

The numeric control searches for the solution by always trying to leave the greatest part of the metal sheet in the operator's hands (the icon that will appears will be the following: ); if you change the calculation "Criterion" selecting **[All the solution]** it is possible to search for the sequence among all the possible solutions, even those potentially dangerous for the operator (the icon that will appears will be the following: ).

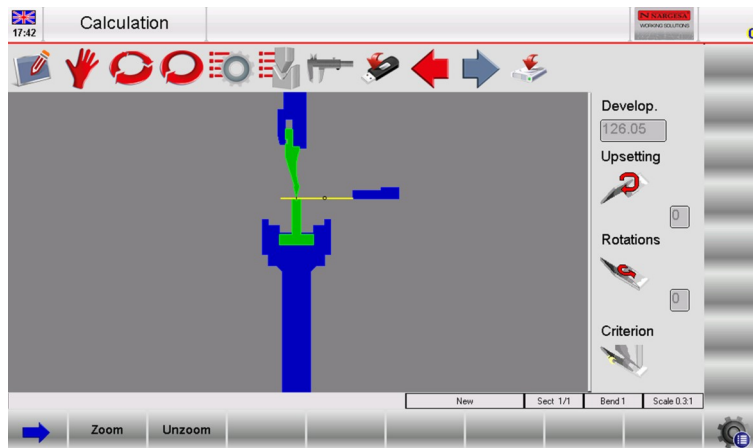

Figure 33 Calculation page of the bending sequence

It is possible to make the calculation of the bending sequence in two modes: automatic or manual.



Automatic search for the bend sequence

In the automatic search, the optimal bending sequence is established by the numeric control; by pressing [Optimize] the numeric control automatically searches for the solution.

Manual search for the bend sequence

In the manual search, the bending sequence is established by the operator who forces the bends.

The bending sequence can be completely or partially forced by the operator: in the case of the sequence only being partially forced, the remaining bends will be calculated automatically by the numeric control.

The operator has the possibility to move between the various bends by pressing the  and  buttons.

To force the bends it is necessary to press the **[Bend]** key in correspondence of the selected bend; if you press the key in correspondence of a bend that has already been forced, that bend will be straightened.

The operator has the possibility of rotating the piece pressing the **[Rotate]** key;

Press [Optimize] when you want to force the desired bends.

The numeric control searches for the solution while keeping in mind the sequence forced by the operator.

Results of the optimisation

If the piece is not feasible, the control will warn the operator with a “No Solution” message.

In this case the operator can try to make the calculation using the criterion that carries out the search for all the solutions.

In the event that there is no possible solution, the operator can try to identify which bend makes it impossible to bend the piece from the manual search of the bend sequence; any collision of the piece with the various parts of the machine is notified by a colour change on the side of the piece that enters into collision.

In order to bend a piece even if it enters into collision (for example in the case in which the collision does not damage the sheet metal) the operator must force the entire bend sequence.

If the piece is feasible the control advises the operator with a “Solution found” message; the operator can select the following functions in this window:

- **[0 STOP]**: the optimisation is stopped in order to make changes.
- **[1 Continue]**: a different solution to the one just found will be searched; if you continue to refuse to accept the solutions proposed, the numeric control will search until it comes to the end of the different solutions, and then it will display the message **“No Solution!!”**.
- **[2 Simulate]**: the simulation of the bending of the piece is displayed; the user can continue with the bending sequence by pressing [1 Continue] or stop the simulations by pressing **[0 STOP]**.
- **[3 Confirm]**: the values calculated in the solution found will be set in the program.

Simulation

Once the solution has been accepted, it will be possible to simulate the bending sequence obtained in the optimisation window of the graphic program:

- Press the function key **[Simulate]**, the piece without bends, set up and ready for the first bend will be displayed.
- Press the function key **[Rest/Support]**, as many times as necessary, to select the first support, the second support (if available) or the rest of the piece. Obviously the stop will only move into the supported position if there aren't collisions and if the limits of the axes permit.
- Press the function key **[Continue]**, the piece will be displayed with the first bend already made.
- Press the function key **[Continue]**, the piece will be displayed with the first bend already made and in position for the second bend.
- To stop the simulation press the function key **[Stop]**, to return to the previous step in the simulation press the function key **[Previous]**.
- Press the function key **[Continue]**, until the end of the simulation (the function key **[Simulate]** will reappear)

Rest/support mode

Once the solution has been accepted, it will be possible realize a support bend in the optimisation window of the graphic program:

- Press the function key **[Simulate]**, the piece without bends, set up and ready for realize the first bend will be displayed.
 - Press the function key **[Rest/support]**, as many times as necessary, to select the first or second supporting of the piece (if available), obviously the stop will only move into the supported position if there aren't collisions and if the limit heights of the axes permit.
 - Press the function key **[Continue]**, the piece will be displayed with the first bend already made.
 - Press the function key **[Continue]**, the piece will be displayed with the first bend already made and in position for the second bend.
 - Press the function key **[Rest/support]** as many times as necessary, to select the first or second supporting of the piece (if available), obviously the stop will only move into the supported position if there aren't collisions and if the limit heights of the axes permit.
 - To stop the simulation press the function key **[Stop]**, to return to the previous step in the simulation press the function key **[Previous]**.
 - Press the function key **[Continue]**, until the end of the simulation (the function key **[Simulate]** will reappear)
 - The function is displayed in the numeric program at the top, on the right hand side of the type of bend.
- The control automatically calculates the corrections necessary on the X and the R. The function key **[Rest/support]**, in numeric mode will not work if the program is graphic. To change the rest/support it is necessary to enter the simulation page.



3.5 Manual calculation of the bending sequence (Optional in the S630 model)

It is possible access the manual calculation procedure from the drawing page of the piece by following the steps below:

- Press **[Calculate]**.



Calculation window

A window will open that shows the simulation of the piece to be bent, including the lower and upper part of the press-brake, the punch, the die, the stops and the piece before to being bent.

On the right side of the page there are three windows that respectively indicate the upsetting and the number of rotations of the piece relating to the bending sequence found (refer to the figure in the paragraph on the Automatic calculation of the bend sequence).

Manual searching for the bend sequence

In the manual search the bending sequence is established by the operator by forcing the bends.

The operator has the possibility to move between the various bends by pressing the  and  buttons.

To force the bends it is necessary to press the **[Bend]** key in correspondence of the selected bend; if you press the key in correspondence of a bend that has already been forced, that bend will be straightened.

The operator has the possibility of rotating the piece pressing the **[Rotate]** key;

Press **[Optimise]** when all the desired bends have been forced.

The numeric control searches for the solution keeping in mind the sequence forced by the operator.

Results of the optimisation

If the piece is not feasible, the control will warn the operator with a **“Forced Solution”** message.

In the event that there is no possible forced solution the operator can try to identify which is the bend that makes it impossible to bend the piece from the manual search of the bend sequence; any collision of the piece with the various parts of the machine is notified by a colour change on the side of the piece that enters into collision.

In order to bend a piece even if it enters into collision (for example in the case in which the collision does not damage the sheet metal) the operator must force the entire bend sequence.

If the piece is feasible the control advises the operator with a **“Solution Found”** message; the operator can select the following functions in this window:

- **[Stop]**: the optimisation is stopped in order to make changes.
- **[Accept]**: the values calculated in the solution found are set in the program.

Simulation

In the optimisation window of the graphic program, once the solution has been accepted, it will be possible so simulate the bending sequence obtained:

- Press the function key **[Simulate]**, the piece without bends will be displayed, set up and ready for realize the first bend.
- Press the function key **[Rest/support]**, as many times as necessary, to select the first or second supporting of the piece (if available), obviously the stop will only move into the supported position if there aren't collisions and if the limit heights of the axes permit.
- Press the function key **[Continue]**, the piece will be displayed with the first bend already made.
- Press the function key **[Continue]**, the piece will be displayed with the first bend already made and in position for the second bend.
- To stop the simulation press the function key **[Stop]**, to return to the previous step in the simulation press the function key **[Previous]**.
- Press the function key **[Continue]**, until the end of the simulation (the function key [Simulate] will reappear)



Rest/support mode

In the optimisation window of the graphic program, once the solution has been accepted, it will be possible realize a supported bend:

- Press the function key **[Simulate]**, the piece without bends will be displayed, set up and ready to realize the first bend.
 - Press the function key **[Rest/support]**, as many times as necessary, to select the first or second supported position (if available) or the resting-against position of the piece, obviously the stop will only move into the supported position if there are collisions and if the limit heights of the axes permit.
 - Press the function key **[Continue]**, the piece will be displayed with the first bend already made.
 - Press the function key **[Continue]**, the piece will be displayed with the first bend already made and in position for the second bend.
 - Press the function key **[Rest/support]**, as many times as necessary, to select the first or second supported position (if available) or the resting-against position of the piece, obviously the stop will only move into the supported position if there are collisions and if the limit heights of the axes permit.
 - To stop the simulation press the function key **[Stop]**, to return to the previous step in the simulation press the function key **[Previous]**.
 - Press the function key **[Continue]**, until the end of the simulation (the function key **[Simulate]** will reappear)
 - The function is displayed in the numeric program at the top, on the right hand side of the type of bend.
- The control automatically calculates the corrections necessary on the X and the R. The function key **[Rest/support]**, in numeric mode will not work if the program is graphic. To change the rest/support mode it is necessary to enter in the simulation page.

Changing the bend sequence

Once the bend sequence has been optimised, it will be possible to change the bending sequence obtained:

The operator has the possibility of moving among the various bends by pressing the  and  buttons. To remove the bends it is necessary to press the **[Bend]** key in correspondence of the selected bend, remove the other bend you wish to exchange, and press **[Bend]** to select the new sequence desired on each bend removed.

3.6 How to bend a box

The numeric control does not allow to directly set the development on the flat of a box to be bent. To be able to bend a box it is necessary to set a program with two bend sections (it doesn't matter if the program is graphic or numeric) in which to set the bends relating to the horizontal section and the bends relating to the vertical section respectively.

The two programs will be realized one after the other, thus making it possible to create the box.



The execution of a program with several sections always starts from the section with the smallest width of the sheet metal.

How to add or delete a section

To add a section in graphic or numeric, it is necessary to press the function key [Change Section] whereas to delete a section, move onto the desired section and follow the steps below:

- Press the  button to open the menu.
- Select the item **6>> Delete section**; the section will be deleted and the program will move onto bend 1 of section 1.

3.7 Work data

It is possible to check the absolute TDC, Mute and Pinch Point of a bend, in the following manner:

- Press the  button to open the menu.
- Select the item **7>> Work informations**; a window will appear containing the absolute TDC, Mute and Pinch point.
- To exit press **[Ok]**.

3.8 Execution of a program in automatic mode

After setting a numeric program or calculating a graphic program it is possible run it in automatic.

Automatic mode can be enabled by pressing the  button.

Automatic graphic page

If the program currently selected is a calculated graphic program the automatic graphic page can be viewed by pressing [Graphic]; this page consists of three windows:

The main window contains the drawing of the upper and lower parts of the machine, the drawing of the punch and the die entered in the program, the drawing of the piece before and after the bend, and the drawing of the stop.

The second window shows how to orient the piece for each bend (upsetting or rotation of the metal sheet compared to the previous bend).

The third window contains the data of the bend in progress, the piece counter and the Development of the metal sheet.

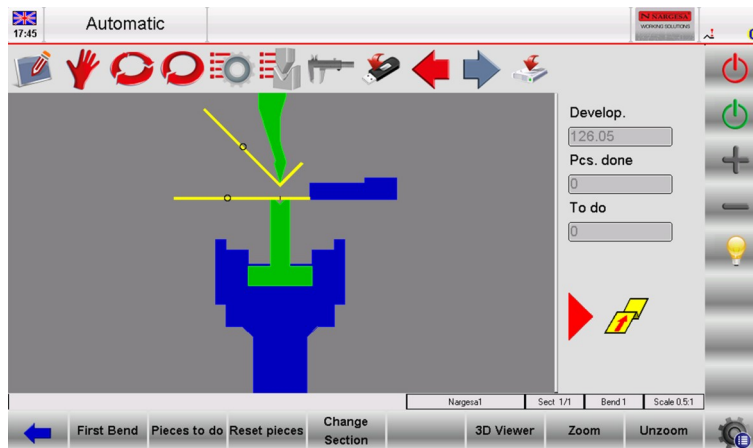

Figure 34 Automatic graphic page

Automatic numeric page

If the program currently selected is numeric, added to the numeric setting data there will also be the current quota of the axes; it is not possible to change the program data in automatic mode.

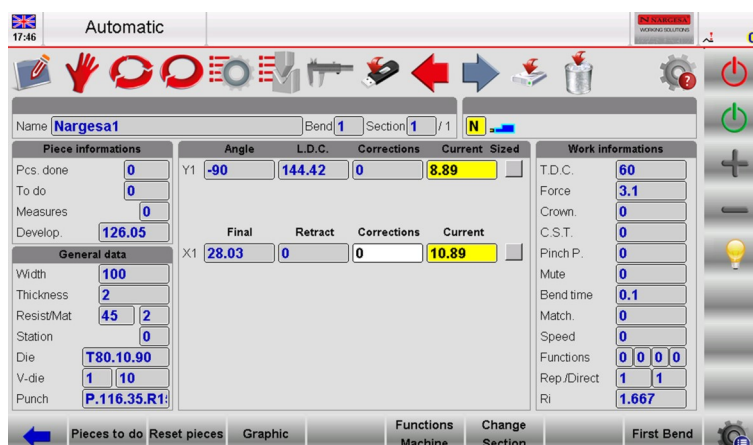



Figure 35 Automatic numeric page

- In order to have a better view of the heights of the axes, it is possible to double the size of the characters of the page.

This page is enabled by pressing 

- To return to the page with single size characters press  again.

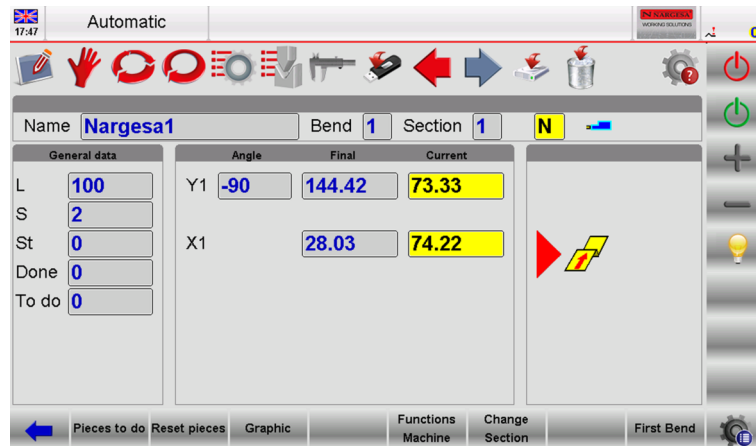



Figure 36 Double size automatic numeric page

Carrying out the automatic cycle

To start an automatic cycle just press the **START**  button; this operation enables the positioning of the back gauges axes. At the end of the positioning of the back gauges axes press the **down pedal** to move down the ram and make the bend.

Once the bend has been made, the ram will automatically return and the positioning of the back gauges axes relating to the next bend will take place.

Once the last bend of the program has been made, the automatic cycle will start from the first bend.

First bend

This allows you to view the first bend to realize. Select **[First Bend]**

Execution of the sample piece

The calculations made by the numeric control are purely theoretical and due to the imperfection of the sheet metal, it may be necessary to make corrections to the values calculated.



To simplify the correcting of the bend data of a piece there is a procedure to perform a sample piece in the SEMI-AUTOMATIC page.

In SEMIAUTOMATIC, at the end of a bend there is no step change, instead the cycle remains on the current bend to allow the operator to correct the bend data and then repeat the bend that has been corrected.

It is possible to make step-by-step corrections to the angle or the length of the bend for all the bends.

The corrections entered are automatically illustrated in the program.

The procedure can also be enabled from the AUTOMATIC page in the following manner:

- Press 
- Press the  button to position the back gauges axes.
- Press the down pedal to execute the bend.
- Measure the bend made in terms of bend length and angle.

If the bend is not correct:

- Press  to access the correction data. If you need to make a correction to all the steps (e.g.: if all the bends have to be at the same angle it is recommended to correct the program in general mode), enter the data in the “Piece” column. If you need to correct the data of a section, enter the data in the “Section” column, or if you want to correct the data relating to a bend, enter the data in the Bend column.
- Enter the correction data.

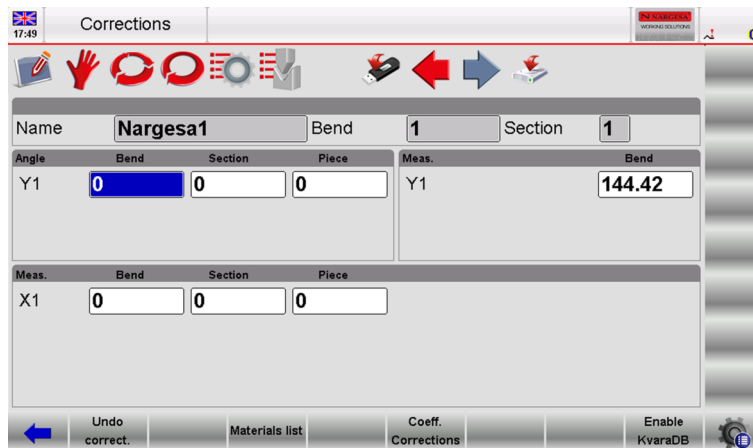

Figure 37 Correction page

Setting of the correction data

The correction data to be entered are in mm for the position of the back gauges axes, and in degrees for the bend angle; the data entered will be added to the value contained in the program.

Example: if the bend is closed by 2° it is necessary to enter a positive correction value (+2.0°); if the bend is open by 2° it is necessary to enter a negative correction value (-2.0°).

If the length of the bend is less than the desired length you must enter a positive value in the **Corr. X1** Field corresponding to the difference detected; if the length of the bend is greater than the desired length you must enter a negative value in the **Corr. X1** Field corresponding to the difference detected.

If several corrections are made to the data of the same bend, the last value entered will be added to the previous ones.

Example: if a bend is initially closed by 3° and after the correction (+3.0°) it is open by 1°, it will be necessary to enter 1.0° in the field for correcting the angle.





During the correction of the step, the correction data of the angles are separated per cylinder; it is therefore possible to correct the angle of Y1 in a different manner to the angle of Y2.

In the general correction the bend angle will be corrected the same way for both cylinders.

If a correction to the pitch is made as well as a correction to the piece during the same step, the values entered will match.

Example: if a step correction is made equal to -2.0° and a piece correction equal to -1.0° , the angular correction of that step will be -3.0° .

At the end of the operation for setting of the correction data:

- Press 
- Press the  button to reposition the back gauges axes (a correction may have been made to their position).
- Repeat the bend.
- Check that the bend is correct:
- If correct: Repeat the procedure for all the bends of the program; to move between the various bends press the  or  buttons.
- If incorrect: Make new variations to the data corrections of the current bend.

Once the data have been corrected for all the bends:

- Press ; the automatic cycle will start from the bend currently selected.
- There are new methods for setting the corrections which are described below.

Corrections internal radius

It is possible to display the internal radius of the bend on the Editor page. The internal radius is always calculated, either in graphic or numeric, the calculation method can be selected from the generic parameters. The change of the internal radius will influence the stretch calculations, but only if the program is numeric. If the program has been generated in graphic, the change to the internal radius will not recalculate the stretching.

Consult the machine parameters manual for the various application modes for the internal radius.

3.9. Selection of the DIN formula to calculate the stretch

It is possible to select the standard DIN formula if you need to use it (for calculating the stretch). In order to select the standard formula, set the generic Stretching Formula parameter to 1. This Field can also be changed by the operator from the **4>> User Parameters page**.

Checking the program

Once the changes have been made, press START  to take the axes into position. The check of the program will be realized automatically and in case any errors are detected, a message will then be sent which will remain in semiautomatic STOP status.



Self-Teach cycle

There are special situations in which it is not possible to use the bend quota calculated by the numeric control for carrying out a bend (rounded punches, coining bends, bends outside the V-die, etc...).





In these circumstances it is helpful to use the self-learning cycle of the bend quota (L.D.C. point) you want to insert on the SEMIAUTOMATIC page.

If this procedure is activated, any step change will be made at the end of a bend, the cycle will remain on the current bend to allow the operator to execute the self-learning of the desired height of the end of the bend (L.D.C. point).

In order to find the correct height of the end of the bend the operator can adopt various methods:

- If the quota to be reached is greater than the quota of the end of the bend calculated, the new quota can only be searched using the up pedal ;
- If the quota to be reached is lower than the quota of the bend calculated, the operator must enable the Re
- Ascent to TDC with ascent enabling input, and without releasing the down pedal at the quota of the end of the bend have to press the  or the Start  button in order to go down by a tenth or a hundredth of millimetre at a time.

The procedure can be activated from the SEMIAUTOMATIC page like following:

- Press 
- Press the START  button to position the back gauges Axes;
- Press the Down pedal for make the bend;
- Search for the point of the desired end of the bend via the procedure described above;
- Press [Y self-teach.];
- Press the up pedal;
- Repeat the procedure for all the bends of the program; in order to move between the various bends use the  and  button.

Once the self-teaching has been completed for all the bends:

- Press  and execute the program from the first bend.

Annex 2

Technical data

List of parts
Hydraulic group
Upper cylinder
Main cylinder
Electric box
Control panel box
Electric maps
Hydraulic map



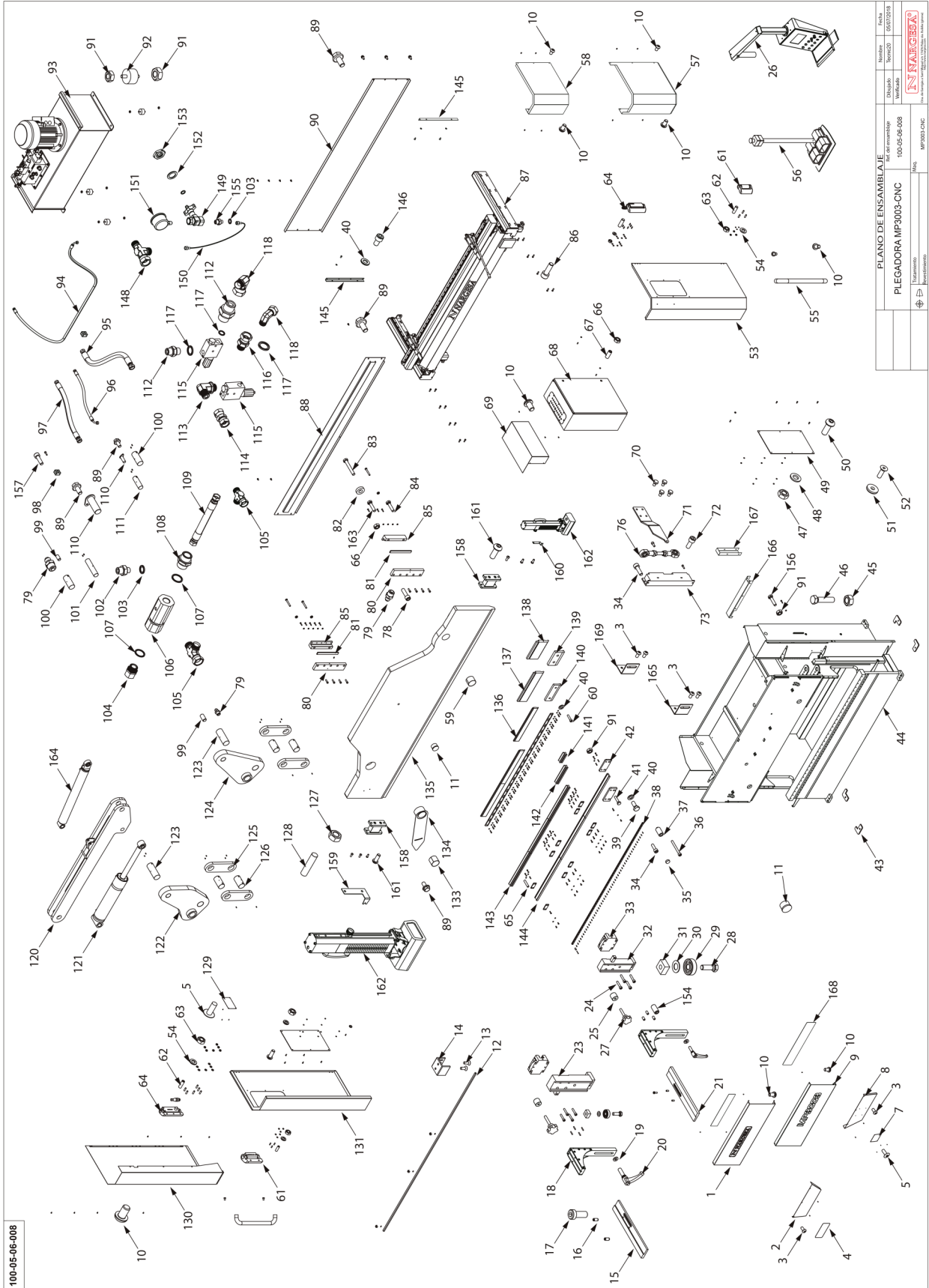





1. List of parts

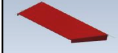
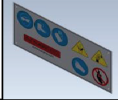
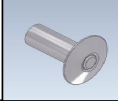
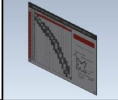
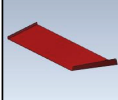

100-05-06-008

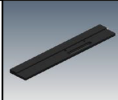

PLANO DE ENSAMBLAJE		Modelo	MP3003-CNC
REF. del inventario		Revista	05/07/2018
100-05-06-008		Verificado	
Máquina		N NARGESA	
Módulo		MP3003-CNC	
Partes/Componentes			

PRESS BRAKE MP3003CNC · TECHNICAL DATA

Elemento	Miniatura	Nº de pieza	Descripción	CTDAD
1		120-05-06-00482	TAPA FRONTAL SUPERIOR IZQUIERDA MP3003CNC	1
2		120-05-06-00379	CHAPA DELANTERA IZQUIERDA	1
3		020-I7380-M6X12	Tornillo Allen Abombado ISO7380 M6X12	10
4		122-CAL-0506-004	PLACA ALUMINIO ADVERTENCIAS PLEGADORA	1
5		020-D7337-3X8	Remache De Clavo DIN7337 De Al D3X8	12
7		122-CAL-0505-002	TABLA ESPECIFICACIONES	1
8		120-05-06-00378	CHAPA DELANTERA DERECHA	1
9		120-05-06-00481	TAPA FRONTAL SUPERIOR DERECHA MP3003CNC	1
10		020-I7380-M6X10	Tornillo Allen Abombado ISO 7380 M6X10	48
11		031-TAP-00005	Tapon De Plastico Para Tubo Redondo D25	1
12		050-LED-00009	Tira Led 2730mm MP-3003	1
13		020-D7991-M3x8	TORNILLO ALLEN DIN 7991 M3X8	8
15		120-05-08-00168	GUIA SUPERIOR IZQUIERDA SOPORTE CHAPA	1
16		030-D7979D-00001	PASADOR CILINDRICO DIN 7979D D8X16	4
17		020-D6912-M8X20	Tornillo Allen Cabeza Reducida Din6912 M8X20 8.8 Pavonado	2
18		130-05-06-00264	CONJUNTO DESLIZANTE SOPORTE CHAPAS MP3003CNC	2

Elemento	Miniatura	Nº de pieza	Descripción	CTDAD
19		120-05-06-00423	ARANDELA VERTICAL	2
20		031-MAG-00006	EMPUÑADURA GRADUABLE M16X50	2
21		120-05-08-00171	GUIA SUPERIOR DERECHA SOPORTE CHAPA	1
23		130-05-06-00239	CONJUNTO GUIA IZQUIERDA SOPORTE CHAPAS MP3003CNC	1
24		020-D912-M8X40	TORNILLO ALLEN DIN 912 M8X40	8
25		120-05-06-00452	TOPE POSICION BRAZOS PORTA CHAPA	2
26		130-05-06-00251	CONJUNTO FINAL BRAZO SOPORTE CONTROL MP3003 CNC	1
27		031-POMM-00010	Pomo Macho Lobulos Ø50 - M10x40	2
28		020-D933-M12X35	Tornillo Hexagonal DIN 933 M12x35	2
29		030-CJ-00038	Rodamiento De Bolas Tapado 6301-2RS D12XD37X12	2
30		120-05-06-00424	ARANDELA COJINETE	2
31		120-05-06-00421	TUERCA FIJACION COJINETE	2
32		130-05-06-00240	CONJUNTO GUIA DERECHA SOPORTE CHAPAS MP3003CNC	1
33		030-PL-00001	PATIN LINEAL	2
34		020-D912-M6X20	TORNILLO ALLEN DIN912 M6X20	50
35		031-TG-00001	TAPON GUIA LINEAL AGUJERO M6	50







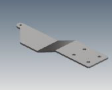

PRESS BRAKE MP3003CNC · TECHNICAL DATA

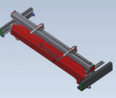
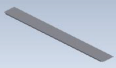
Elemento	Miniatura	Nº de pieza	Descripción	CTDAD
36		020-D912-M6X60	TORNILLO ALLEN DIN 912 M6X60	2
37		120-05-06-00426	TOPE FINAL GUIA SOPORTE CHAPAS	2
38		120-05-06-00416	GUIA PATIN	1
39		020-D933-M10X25	TORNILLO HEXAGONAL DIN 933 M10X25	24
40		020-D125B-M10	Arandela Biselada DIN125B Para M10	74
41		020-D933-M10X45	Tornillo Hexagonal DIN933 M10X45	12
42		120-05-08-00070	BRIDA DOBLE REGLAS	12
43		120-05-01-00536	Placa Pie Plegadora	4
44		130-05-06-00273	ESTRUCTURA MP3003 CNC	1
45		020-D934-M24	TUERCA DIN 934 M24	4
46		020-D933-M24X100	TORNILLO HEXAGONAL DIN 933 M24X100	4
47		020-D934-M6	Tuerca Hexagonal DIN934 M6	12
48		020-D125B-M6	ARANDELA BISELADA DIN125B PARA M6	12
49		120-05-08-00034	TAPA POLICARBONATO	2
50		020-I7380-M6X16	Tornillo Allen Abombado ISO7380 M6X16	12
51		031-BM-00004	BASE MAGNETICA D32X7 AGUJERO AVELLANADO 5.5-11	2

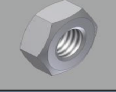
Elemento	Miniatura	Nº de pieza	Descripción	CTDAD
52		020-D7991-M5X16	Tornillo Allen Avellandado DIN7991 M5X16	2
53		130-05-06-00237	CONJUNTO TAPA DERECHA MP3003 CNC	1
54		020-D125B-M5	ARANDELA DIN 125 B M5	22
55		031-APM-00001	ASA INOXIDABLE 250X45 M6	2
56		050-PED-00003	CONJUNTO PEDAL SEGURIDAD	1
57		130-05-06-00261	CONJUNTO TAPA LATERAL DERECHA INFERIOR	1
58		130-05-06-00260	CONJUNTO TAPA LATERAL DERECHA SUPERIOR	1
59		120-05-06-00549	DOLLA PARTIDA D90XD95 cortada a 70mm	1
60		020-D912-M10X40	TORNILLO ALLEN DIN 912 M10X40	42
61		050-BIS-00002	BISAGRA	2
62		020-D913-M5X16	ESPARRAGO ALLEN DIN 913 M5X16	22
63		020-D934-M5	Tuerca Hexagonal DIN934 M5	22
64		050-BIS-00001	BISAGRA DE SEGURIDAD	2
65		020-D913-M10X50	ESPARRAGO ALLEN DIN 913 M10X50	12
66		020-D934-M8	TUERCA HEXAGONALI DIN934 M8	4
67		020-D913-M8X20	ESPARRAGO ALLEN DIN 913 M8X20	4

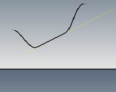
PRESS BRAKE MP3003CNC · TECHNICAL DATA

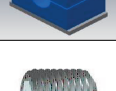
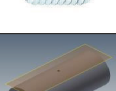
Elemento	Miniatura	Nº de pieza	Descripción	CTDAD
68		050-KIE-0508-002	CONJUNTO ARMARIO ELECTRICO	1
69		130-05-06-00234	CONJUNTO TAPA INSTALACION ELECTRICA	1
70		020-D933-M10X16	TORNILLO HEXAGONAL DIN 933 M10X16 8.8 PAVONADO	4
71		120-05-06-00389	BRAZO ACCIONAMIENTO ENCODER MP3003CNC	1
72		020-D912-M8X20	TORNILLO ALLEN DIN912 M8X20	2
73		050-ENC-00009	Encoder Óptico GIVI GVS200 C.170	1
76		130-05-06-00246	ACCIONAMIENTO ENCODER LINEAL	1
78		020-D912-M12X35	TORNILLO ALLEN DIN 912 M12X35	10
79		020-D71412-00002	Engrasador DIN 71412 M8X1.25 Recto	12
80		120-05-05-00108	GUIA LATERAL MONTANTE	2
81		130-05-05-00022	CONJUNTO AJUSTE GUIA	2
82		120-05-05-00087	ARANDELA DE GRUESO Ø30XØ14.5X8	4
83		020-D931-M14X100	TORNILLO HEXAGONAL DIN 931 M14 X100	4
84		020-D933-M8X35	TORNILLO HEXAGONAL DIN 933 M8x35	9
85		130-05-05-00021	CONJUNTO GUIA TRANCHA	2
86		020-D912-M10X30	Tornillo Allen DIN 912 M10X30	16

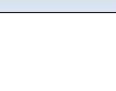

Elemento	Miniatura	Nº de pieza	Descripción	CTDAD
87		130-05-06-00256	Conjunto Tope MP3003CNC + Servomotores + Cubiertas	1
88		130-05-06-00231	CONJUNTO TAPA TRASERA SUPERIOR	1
89		020-D6921-M8X16	Tornillo Hexagonal Embridado Din6921 M8X16	16
90		120-05-05-00003	TAPA TRASERA INFERIOR	1
91		020-D934-M10	Tuerca Hexagonal DIN934 M10	24
92		031-SIB-00003	SILENT BLOCK DOBLE Ø50X30 M10	4
93		130-05-06-00221	CONJUNTO GRUPO HIDRAULICO MP300 CNC	1
94		120-05-06-00404	MANGUERA 3/8 CODO 90º 3/8-TG 3/8 L=2220 mm	1
95		120-05-06-00402	MANGUERA 1" TG 3/4"-TG 1" L= 600 mm	1
96		120-05-06-00403	MANGUERA 3/8" CODO 90º TG 3/8-TG 3/8 L= 540 mm	1
97		120-05-06-00401	MANGUERA 1" TG 3/4"-TG 1" L= 650 mm	1
98		040-ABR-00002	ABRAZADERA PARA TUBO 3/8"	2
99		020-D913-M8X10	ESPARRAGO ALLEN DIN 913 M8X10	14
100		120-05-05-00018	BULON Ø70x164	2
101		120-05-05-00081	BULON Ø55x244	1
102		040-RMM-00002	Racor 1/4" Macho Macho	1



PRESS BRAKE MP3003CNC · TECHNICAL DATA

Elemento	Miniatura	Nº de pieza	Descripción	CTDAD
103		040-JMG-00002	Junta Metal Goma 1/4' Gas	2
104		040-RG-00004	RACOR GIRATORIO M-H 1"	1
105		040-TGL-00002	FIGURA "T" TUERCA GIRATORIA LATERAL 1"	2
106		040-ARP-00001	Antirretorno Pilotado 1"	1
107		040-JMG-00006	Junta Metal Goma 1' Gas	2
108		040-RMM-00007	Racor 1" Macho Macho	1
109		120-05-06-00311	MANGUERA FLEXIBLE 1 - " TG 1" - TG 1" L=360	1
110		130-05-06-00232	Conjunto Bulon Trasero Cilindro Subida MP3003	2
111		120-05-05-00020	BULON Ø55x164	1
112		040-RMM-00003	Racor 3/8" Macho Macho	2
113		040-CGMM-00002	CODO ORIENTABLE MACHO MACHO 3/8"	1
114		040-AH-00001	ACOPLAMIENTO TG-TG 3/8"	1
115		040-VRP-00001	VALVULA REGULADORA PRESION RA03R2B	2
116		040-RG-00003	Racor Giratorio Macho Hembra 3/8"	1
117		040-JMG-00004	Junta Metal Goma 3/8' Gas	3
118		040-CMH-00002	CODO 90º MACHO HEMBRA 3/8"	2

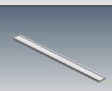
Elemento	Miniatura	Nº de pieza	Descripción	CTDAD
120		130-05-06-00226	CONJUNTO BIELA REENVIO	1
121		130-05-06-00209	Pistón Principal MP3003	1
122		130-05-06-00225	BIELA TRIANGULAR IZQUIERDA	1
123		120-05-05-00016	BULON Ø90x244	2
124		130-05-06-00224	BIELA TRIANGULAR	1
125		120-05-05-00060	BIELA TRANCHA MP3003	4
126		120-05-05-00061	BULON Ø90x164	4
127		020-D934-M14	TUERCA DIN 934 M14	1
128		020-D913-M14X60	ESPARRAGO ALLEN DIN 913 M14X60	1
129		122-PLC-0000-001	Placa Características General	1
130		130-05-06-00259	CONJUNTO TAPA LATERAL IZQUIERDA	1
131		130-05-06-00238	CONJUNTO TAPA IZQUIERDA MP3003 CNC	1
133		120-05-06-00548	DOLLA PARTIDA D90XD95 cortada a 80mm	1
134		130-05-06-00244	CONJUNTO SOLDADO EXCENTRICA MP3003	1
135		130-05-06-00269	CONJUNTO TRANCHA MP3003CNC	1
136		140-05-01-00116	PUNZON PS135.85.R08 835mm	3

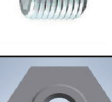
PRESS BRAKE MP3003CNC · TECHNICAL DATA

Elemento	Miniatura	Nº de pieza	Descripción	CTDAD
138		140-05-01-00119	PUNZON PS135.85.R08/T 645mm	1
139		120-05-08-00030	BRIDA REDUCIDA PROMECAM	1
140		120-05-05-00076	BRIDA PROMECAM	20
142		140-05-01-00120	MATRIZ M460R/T 645mm	1
143		140-05-01-00117	MATRIZ M460R 835mm	3
144		140-05-01-00053	Alza Matriz Plegadora C1050/R a 1050mm	3
145		120-05-06-00537	SOPORTE CHAPA TRASERA INFERIOR	2
146		020-D912-M10X16	Tornillo Allen DIN912 M10X16	4
148		040-TGL-00001	Figura 'T' Giratoria Lateral 3/8'	1
149		040-VDP-00002	Grifo Manometro 1/4' Salida Superior Linea Recto Ref. FT290-01-14	1
150		120-05-06-00506	MANGUERA MINIMEX - TG1/4 CONO GAS - TG 3/8 CONO GAS - L=550mm	1
151		040-MAN-00003	Manómetro 0-300 bar D63 1/4 Inferior	1
152		120-05-06-00510	ARANDELA MANOMETRO	2
153		120-09-01-00126	Tuerca Sujeción	1
154		020-D913-M6X20	ESPARRAGO ALLEN DIN 913 M6X20	8
155		040-RRMM-00002	Racor Reducido 3/8'-1/4' Macho Macho	1



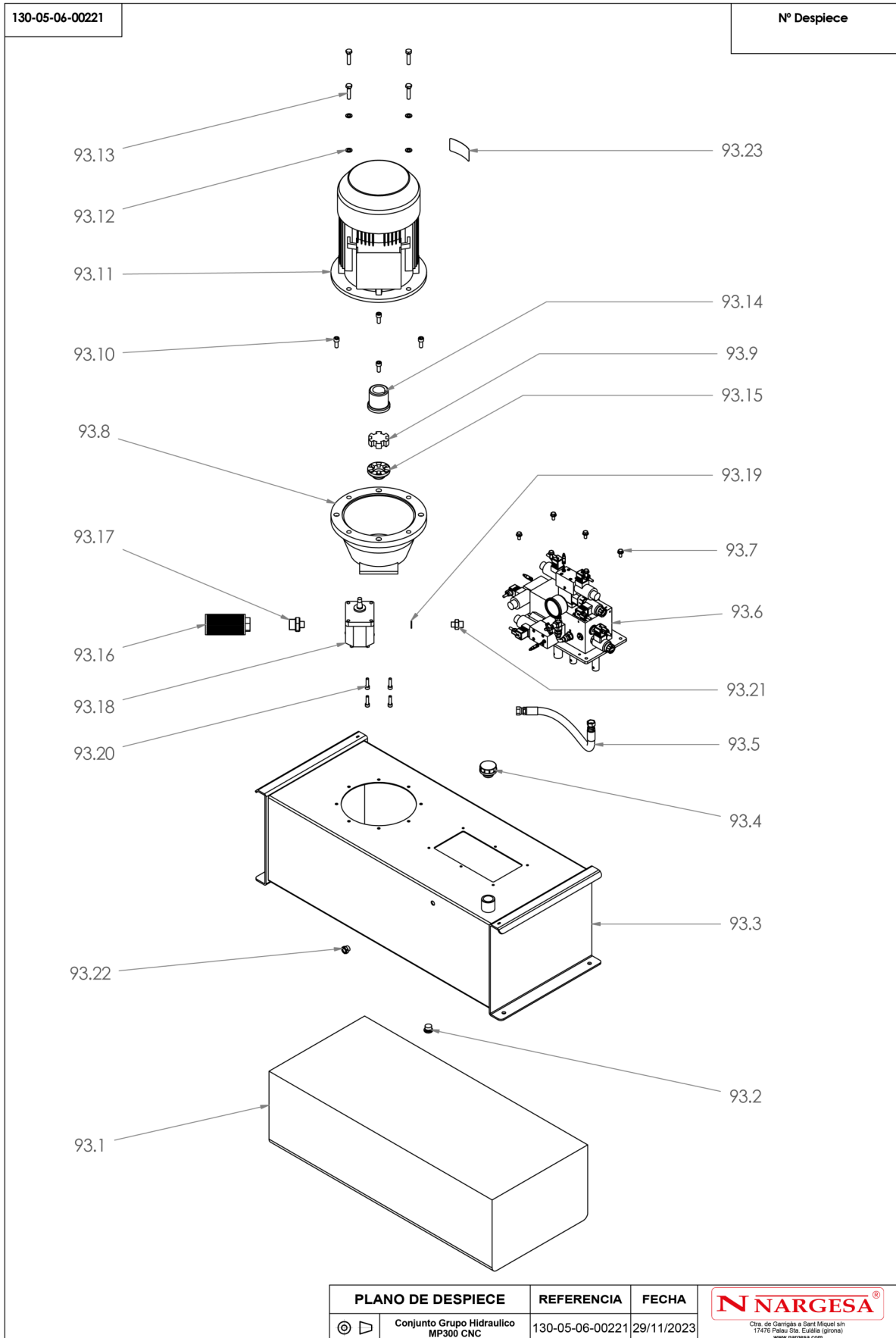

Elemento	Miniatura	Nº de pieza	Descripción	CTDAD
156		020-D933-M10X90	Tornillo Hexagonal DIN 933 M10x90	2
157		020-D912-M6X25	Tornillo Allen DIN912 M6X25	4
158		130-05-06-00265	SOPORTE LASER	2
159		120-05-06-00533	CHAPA INDICADORA POSICION LASER IZQUIERDA	1
160		120-05-06-00534	CHAPA INDICADORA POSICION LASER DERECHA	1
161		020-I7380-M8X20	TORNILLO ALLEN ABOMBADO ISO7380 M8X20	8
162		050-LAS-00001	CONJUNTO LASER PLEGADORA	2
164		130-05-06-00268	CILINDRO SUBIDA MP3003 CNC	1
165		120-05-06-00536	SOPORTE INDUCTIVO TRANCHA	1
166		120-05-06-00540	Tapa passacables inferior	1
167		120-05-06-00541	Tapa cables lateral	1
168		120-05-06-00543	METACRILATO NARGESA	2
169		120-05-06-00545	SOPORTE INDUCTIVO TRANCHA	1
170		050-IND-00004	Detector Inductivo Diell M8 NC PNP-10-30 M12	1
171		050-IND-00003	Detector Inductivo Diell M8 NO PNP-10-30 M12	1

2. Hydraulic group

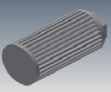

Elemento	Miniatura	Nº de pieza	Descripción	CTDAD
93.1		120-05-06-00547	Aceite Hidráulico HV-46 120L MP3003	1
93.2		040-TVA-00001	Tapon Allen 1/2'	1
93.3		130-05-06-00222	DEPOSITO HIDRAULICO MP3003CNC	1
93.4		040-TLL-00001	Tapon De Llenado 1" Con Filtro	1
93.5		120-05-06-00427	MANGUERA 1/2" TG1/2"-TG1/2" L=560 mm	1
93.6		040-BL-00014	BLOQUE HIDRAULICO PLEGADORAS MP2003/MP3003	1
93.7		020-D6921-M8X16	Tornillo Hexagonal Embridado Din6921 M8X16	6
93.8		040-CA-00001	Campana Acoplamiento Bomba Tipo L Motor 7.5/10/12	1
93.9		040-AE-00004	Estrella Acoplamiento 7.5/10/12 Cv	1
93.10		020-D912-M10X25	Tornillo Allen DIN912 M10X25	4
93.11		050-ME-00004	Motor Eléctrico DE 9.2 KW A 1400 RPM Brida B5	1
93.12		020-D125B-M10	Arandela Biselada DIN125B Para M10	4
93.13		020-D933-M10X45	Tornillo Hexagonal DIN933 M10X45	4
93.14		040-AE-00002	Acoplamiento Lado Motor 7.5/10/12 Cv	1
93.15		040-AE-00003	Acoplamiento Lado Bomba Tipo L 7.5/10/12 Cv	1

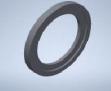
PRESS BRAKE MP3003CNC · TECHNICAL DATA

Elemento	Miniatura	Nº de pieza	Descripción	CTDAD
93.16		040-FL-00003	Filtro De Aspiracion 1'	1
93.17		040-RRMM-00009	Racor Reducido 1'-1/2' Macho Macho	1
93.18		040-BH-00001	Bomba Hidraulica de 22 Litros Carcasa De Aluminio	1
93.19		040-JMG-00004	Junta Metal Goma 3/8' Gas	1
93.20		020-D912-M8X30	Tornillo Allen DIN 912 M8X30	4
93.21		040-RRMM-00004	Racor Reducido 1/2-3/8 Macho Macho	1
93.22		040-NA-00001	Visor Nivel Aceite De 3/8" Gas	1
93.23		122-ADH-00007	Calca Sentido de Giro	1

3. Upper cylinder

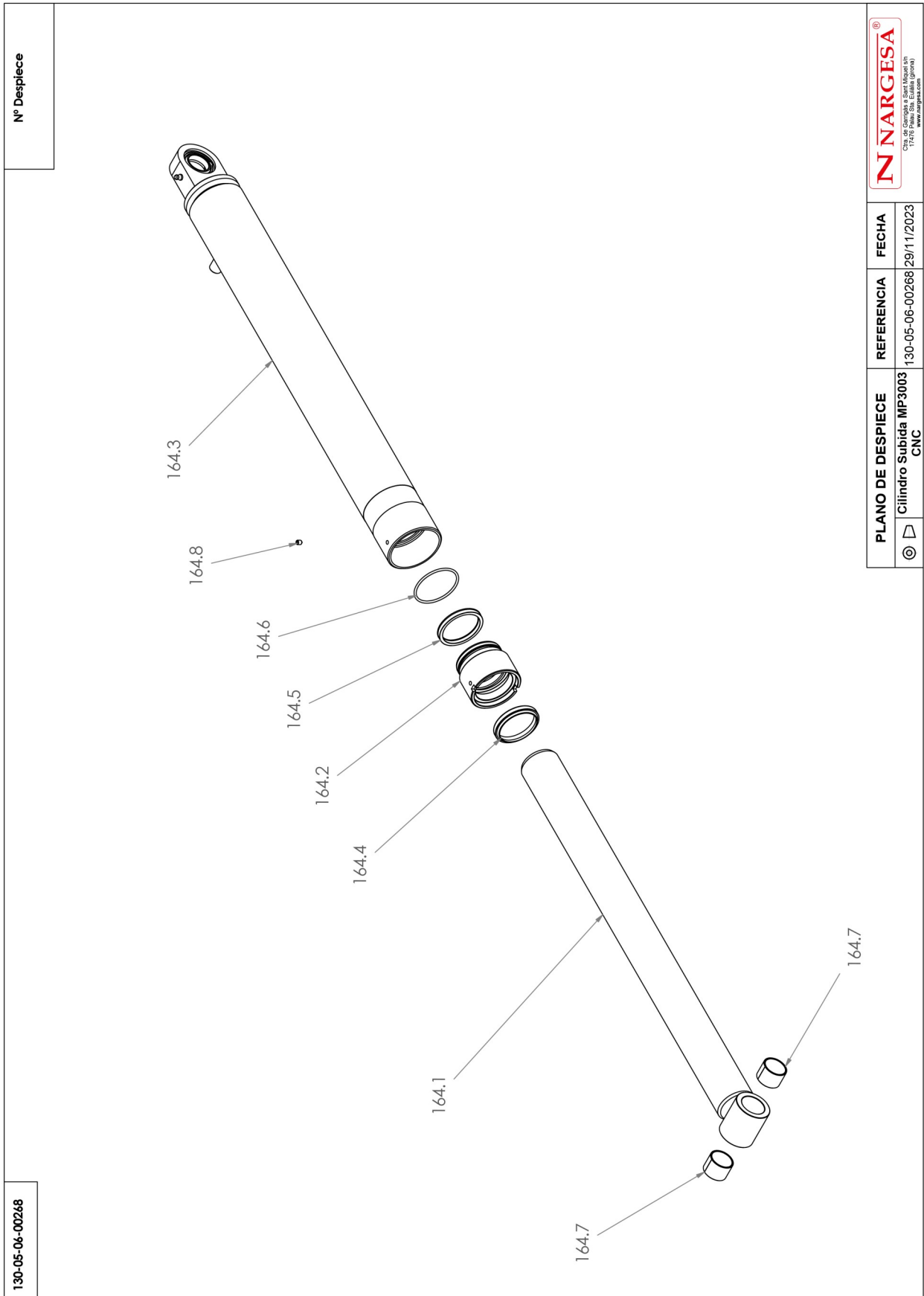

130-05-06-00268





Nº Despiece

PLANO DE DESPIECE	REFERENCIA	FECHA
Cilindro Subida MP3003 CNC	130-05-06-00268	29/11/2023

Este plano es propiedad de Praxair Nargesa S.L. No podrá ser reproducido, comunicado a terceros o utilizado para otro fin que no sea el acordado sin su permiso escrito.

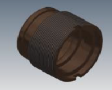
N NARGESA®
 C/da de Camarilla s/n, 28100 San Agustín de Guzmán (Madrid)
 T: +34 91 470 00 00
 www.nargesa.com

PRESS BRAKE MP3003CNC · TECHNICAL DATA

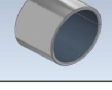
Elemento	Miniatura	Nº de pieza	Descripción	CTDAD
164.1		130-05-06-00229	CONJUNTO VASTAGO CILINDRO SUBIDA MP3003	1
164.2		120-05-06-00532	DOLLA DE BRONCE CILINDRO DE SUBIDA MP3003	1
164.3		130-05-06-00267	CONJUNTO CAMISA CILINDRO SUBIDA MP3003CNC	1
164.4		040-RAS-00009	Rascador D55XD65X7/10	1
164.5		040-BA-00014	Collarin BA D55XD65X7.3	1
164.6		040-JT-00034	JUNTA TORICA D60X3 90 Shore	1
164.7		030-DP-00012	Dolla Partida D30XD34X25	2
164.8		020-D914-M6X8	ESPARRAGO ALLEN DIN 914 M6X8	1

4. Main cylinder

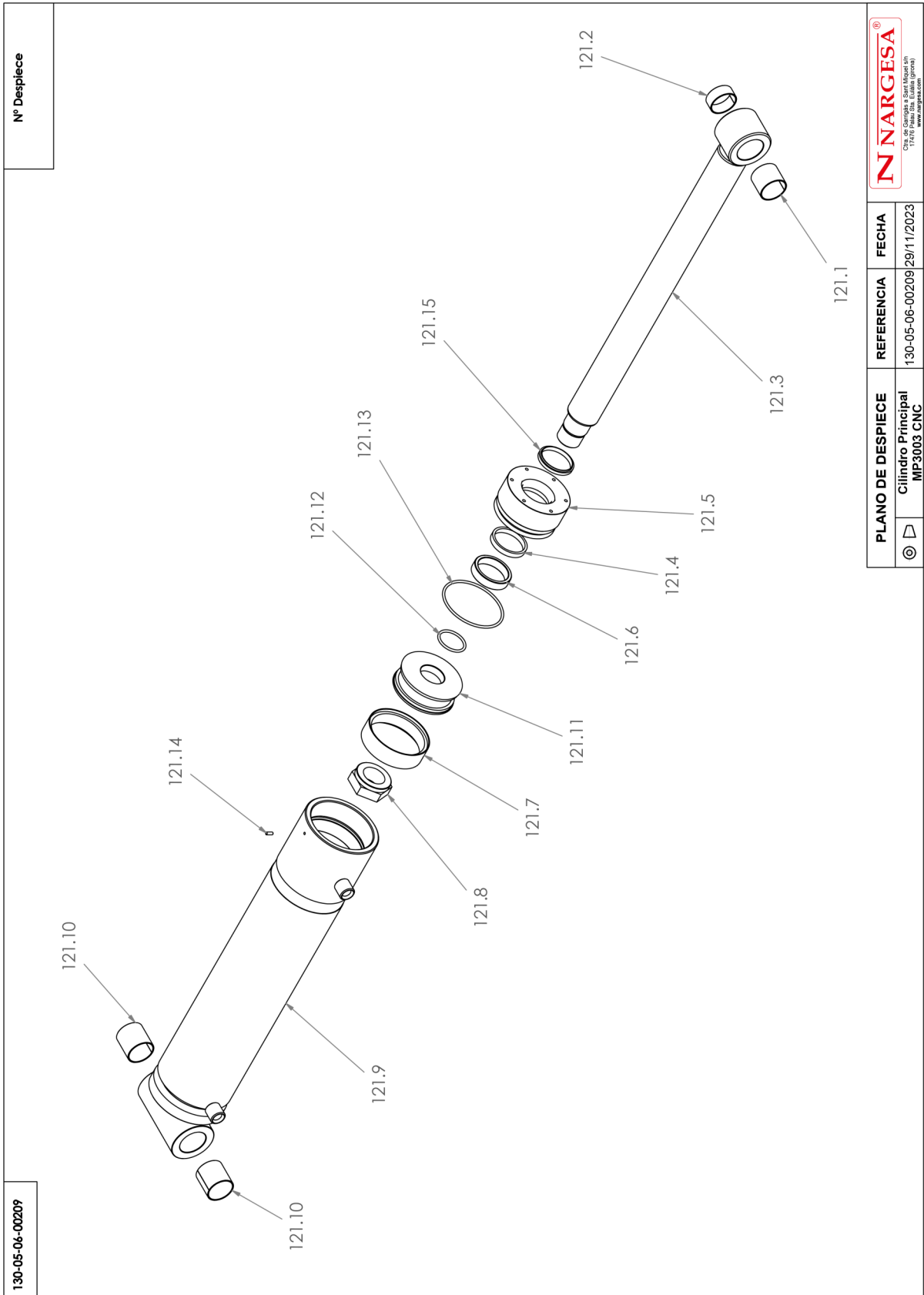

130-05-06-00209

Nº Despiece

PLANO DE DESPIECE	REFERENCIA	FECHA
 Címetro Principal MP3003 CNC	130-05-06-00209	29/11/2023
Ctra. de Camargo a Santa Mónica s/n 11410 San Juan de los Rios www.nargesa.com		
Este plano es propiedad de Pista Nargesa SL. No podrá ser reproducido, comunicado a terceros o utilizado para otro fin que no sea el acordado en su permiso escrito.		

PRESS BRAKE MP3003CNC · TECHNICAL DATA

Elemento	Miniatura	Nº de pieza	Descripción	CTDAD
121.1		030-DP-00024	DOLLA PARTIDA D55XD60X50	1
121.2		030-DP-00022	DOLLA PARTIDA D55XD60X25	1
121.3		130-05-06-00208	CONJUNTO VASTAGO CILINDRO PRINCIPAL	1
121.4		040-BA-00010	COLLARIN BA D70XD80X11.4	1
121.5		120-05-06-00059	DOLLA DE BRONCE CILINDRO PRINCIPAL	1
121.6		120-05-06-00058	SEPARADOR PISTON PRINCIPAL	1
121.7		040-DPS-00002	JUNTA DPS Ø140XØ123X20X40	1
121.8		120-05-06-00349	TUERCA EMPAQUETADURA CILINDRO PRINCIPAL	1
121.9		130-05-06-00020	CANIZACIÓN CAMISA CILINDRO PRINCIPAL MP3003	1
121.10		030-DP-00025	DOLLA PARTIDA D55XD60X60	2
121.11		120-05-06-00322	EMPAQUETADURA CILINDRO PRINCIPAL	1
121.12		040-JT-00017	JUNTA TORICA D55X5 90 Shore	1
121.13		040-JT-00005	JUNTA TORICA D131X5 90 Shore	1
121.14		020-D913-M6X16	Esparrago Allen DIN913 M6X16	1
121.15		040-RAS-00006	RASCADOR 70x80x7/10	1

5. Electric box

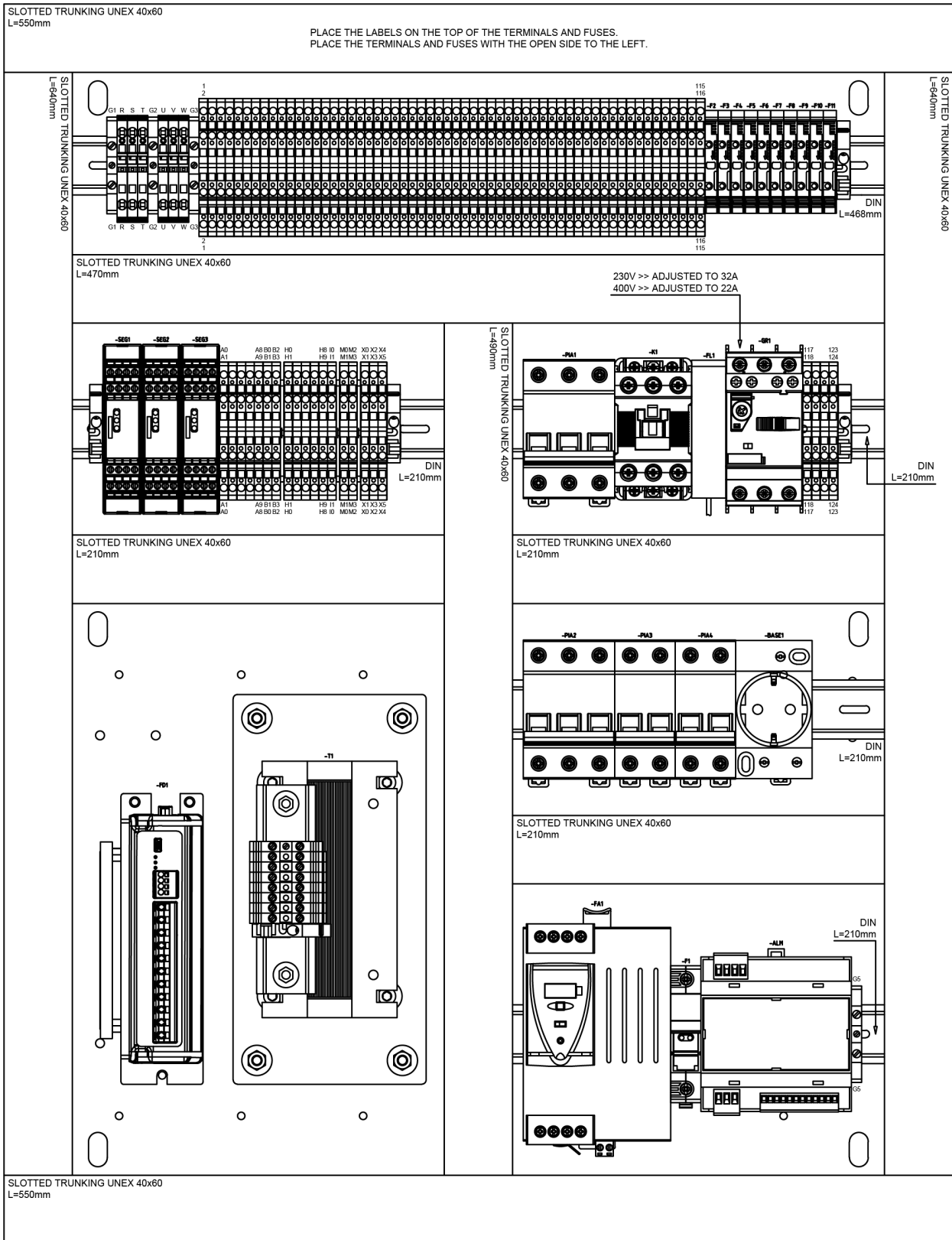

5. Electric box. Only for USA.

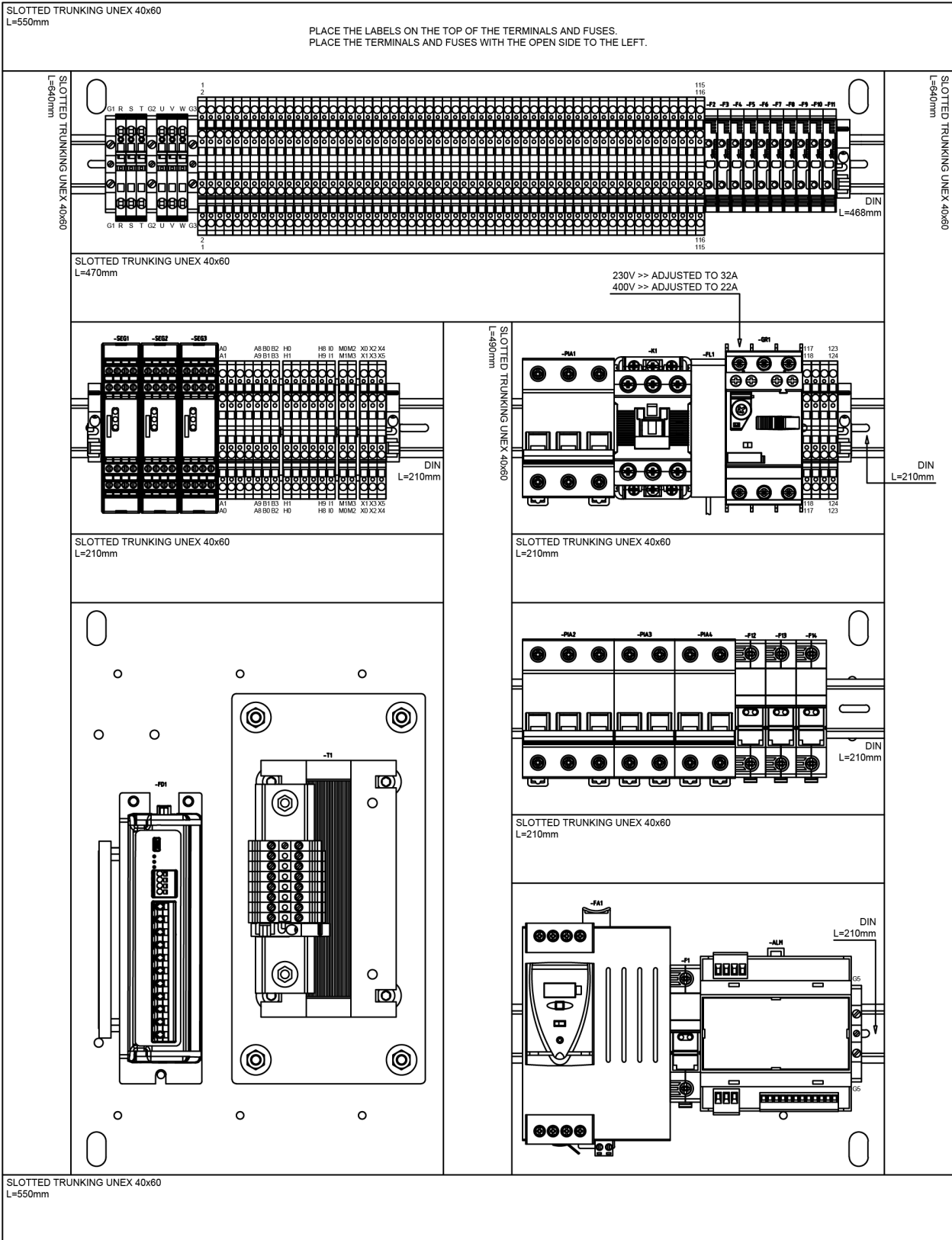

6. Control panel box

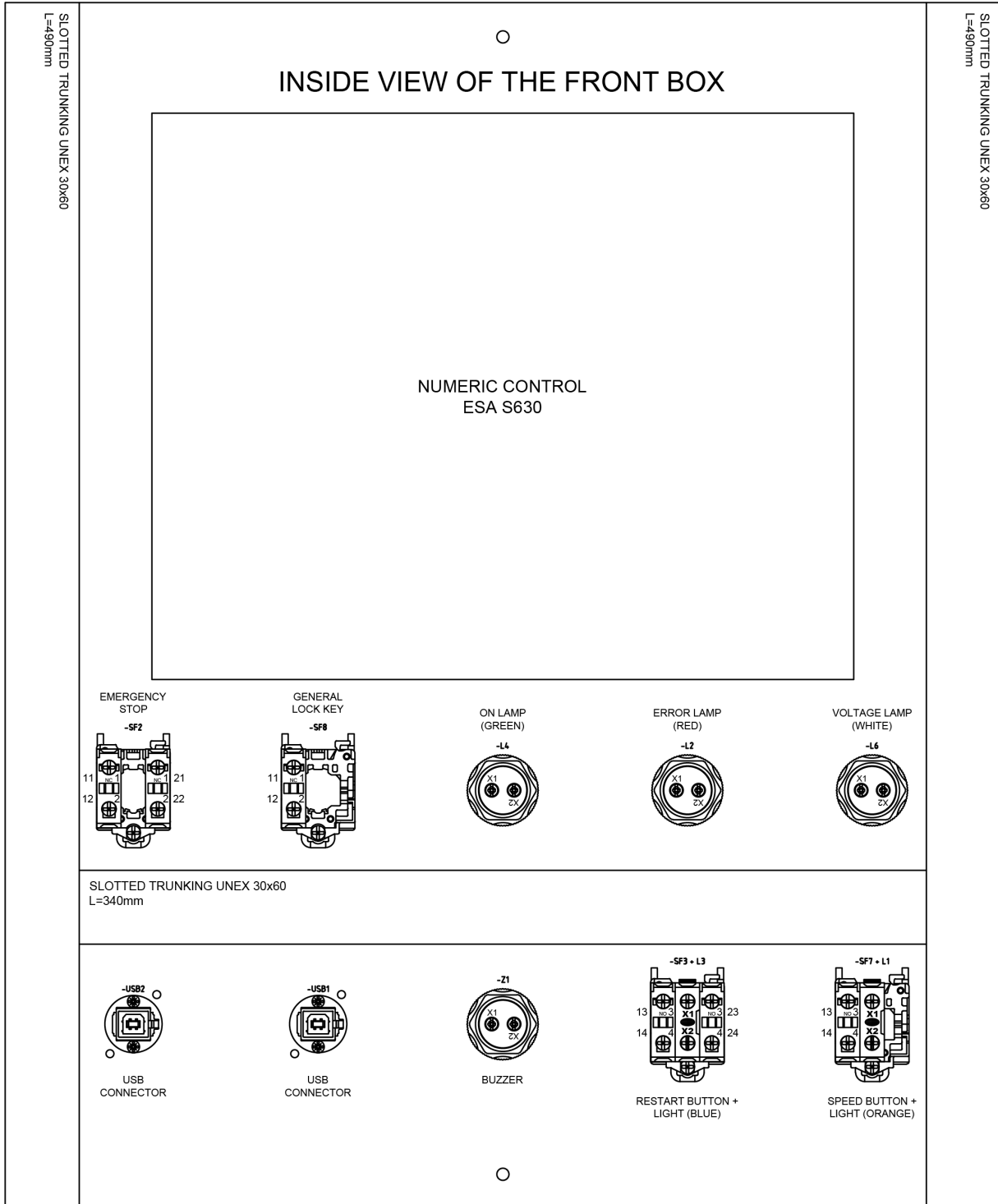

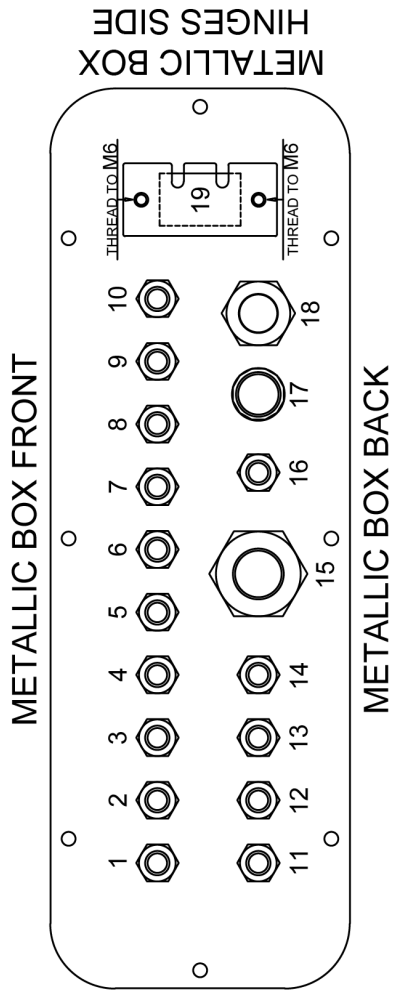

NUMBER	PLASTIC CABLE GLAND	ELECTRIC WIRE	DESCRIPTION
1	PG9	-MG26	EVE1 (PROPORTIONAL PRESSURE ELECTROVALVE)
2	PG9	-MG18	L5 (BEND AREA LAMP)
3	PG9	-MG9	IA1 (A1 ELECTROVALVE INDUCTIVE)
4	PG9	-MG8	IC1 (C1 ELECTROVALVE INDUCTIVE)
5	PG9	-MG7	IB1 (B1 ELECTROVALVE INDUCTIVE)
6	PG9	-MG23	IE1 (ENCODER INDUCTIVE)
7	PG9	-MG5	TX (DSP LASER TRANSMITTER)
8	PG9	-MG28	VSA (DSP LASER TEST INDUCTIVE)
9	PG9	-MG12	SF10 (LEFT SIDE HINGE)
10	PG9	-MG11	SF9 (RIGHT SIDE HINGE)
11	PG9	-MG13	EVD1 (PROPORTIONAL SPEED ELECTROVALVE)
12	PG9	-MG17	EVA1 (A1 ELECTROVALVE)
13	PG9	-MG16	EVC1 (C1 ELECTROVALVE)
14	PG9	-MG15	EVB2 (B2 ELECTROVALVE)
15	M32	-MG27	MESH WITH SIGNAL WIRES
16	PG9	-MG14	EVB1 (B1 ELECTROVALVE)
17	PMA DN12 M20	-MG6	CORRUGATED HOSE WITH RX (DSP LASER RECEIVER)
18	M25	-MG2	PUMP MOTOR
19	---	-MG22 + -MG21	CAN BUS CABLE + ETHERNET EXTENSION CABLE

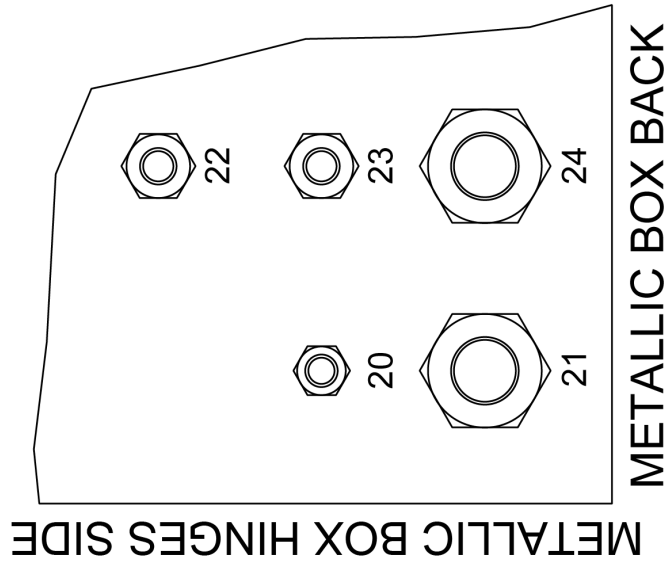

NUMBER	PLASTIC CABLE GLAND	ELECTRIC WIRE	DESCRIPTION
20	PG9	---	---
21	M25	-MG1	POWER SUPPLY
22	M20 RACORD	-MG10	PEDAL
23	PG13.5	-MG24 + -MG25	ITX (X AXIS, BACK GAUGE INDUCTIVE) + ITR (R AXIS, BACK GAUGE INDUCTIVE)
24	M25	-MG3	BACK GAUGE MOTOR / DRIVER HOSE

7. Hydraulic group

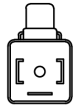

MOUNTING DIRECTION FOR ALL VALVES

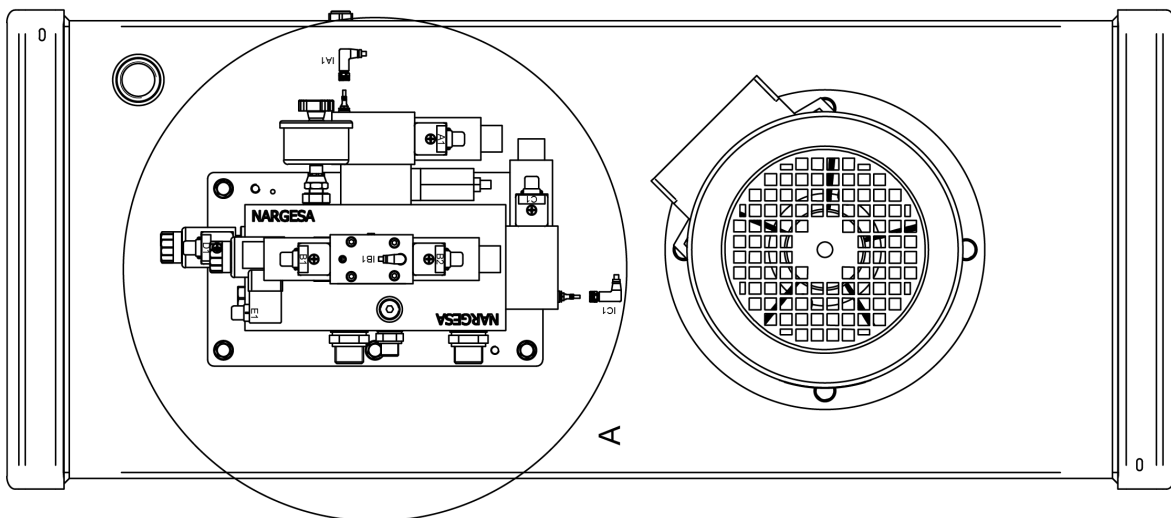
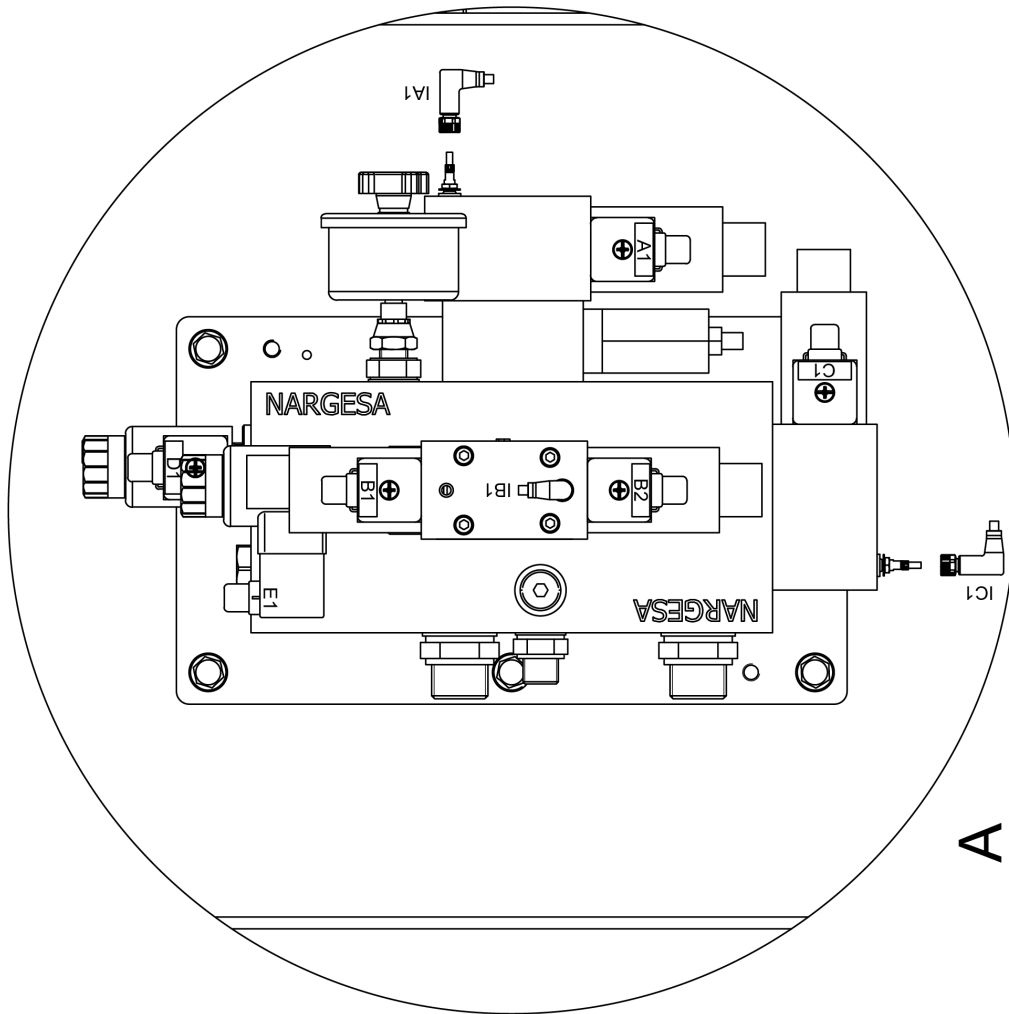

8. Electric maps

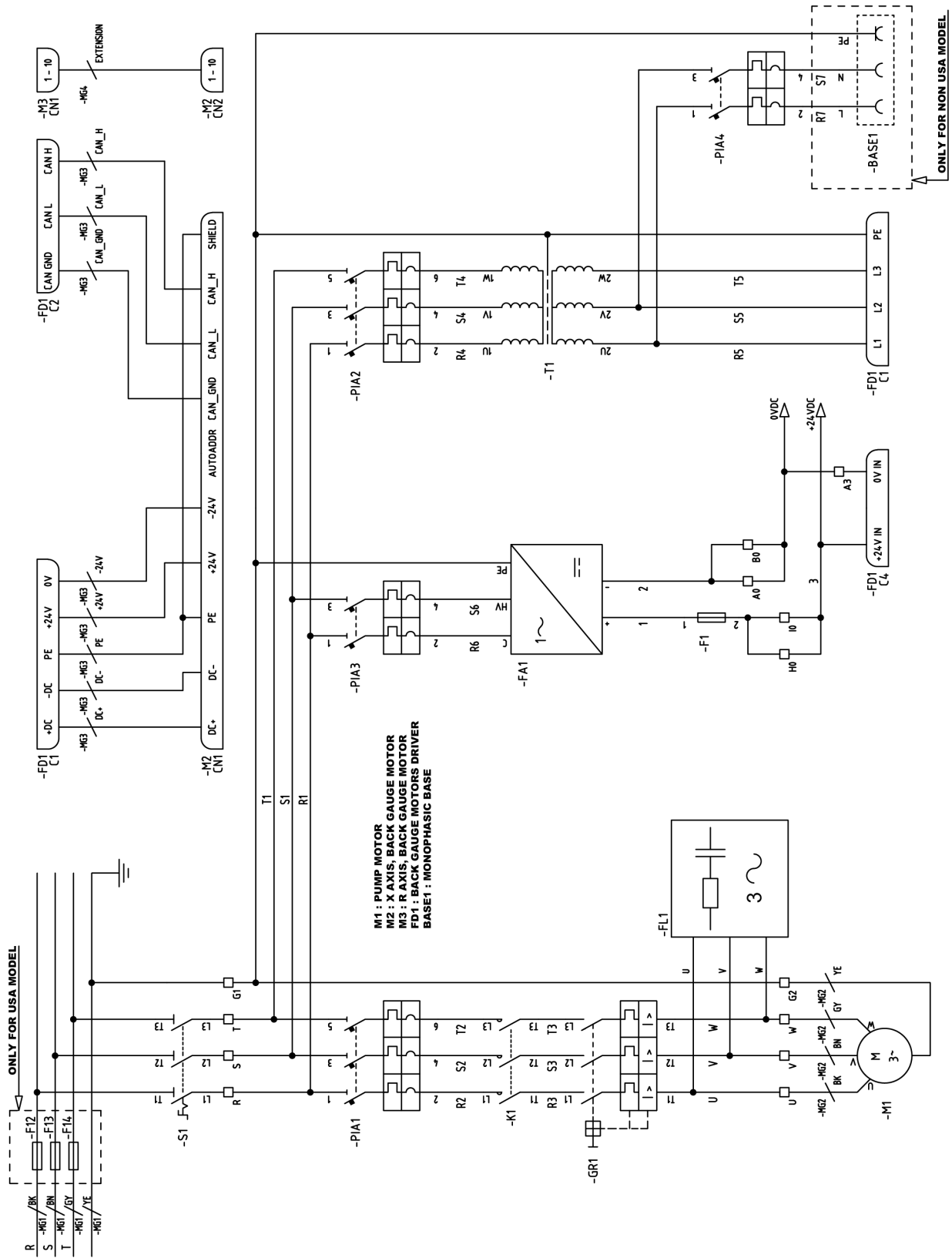

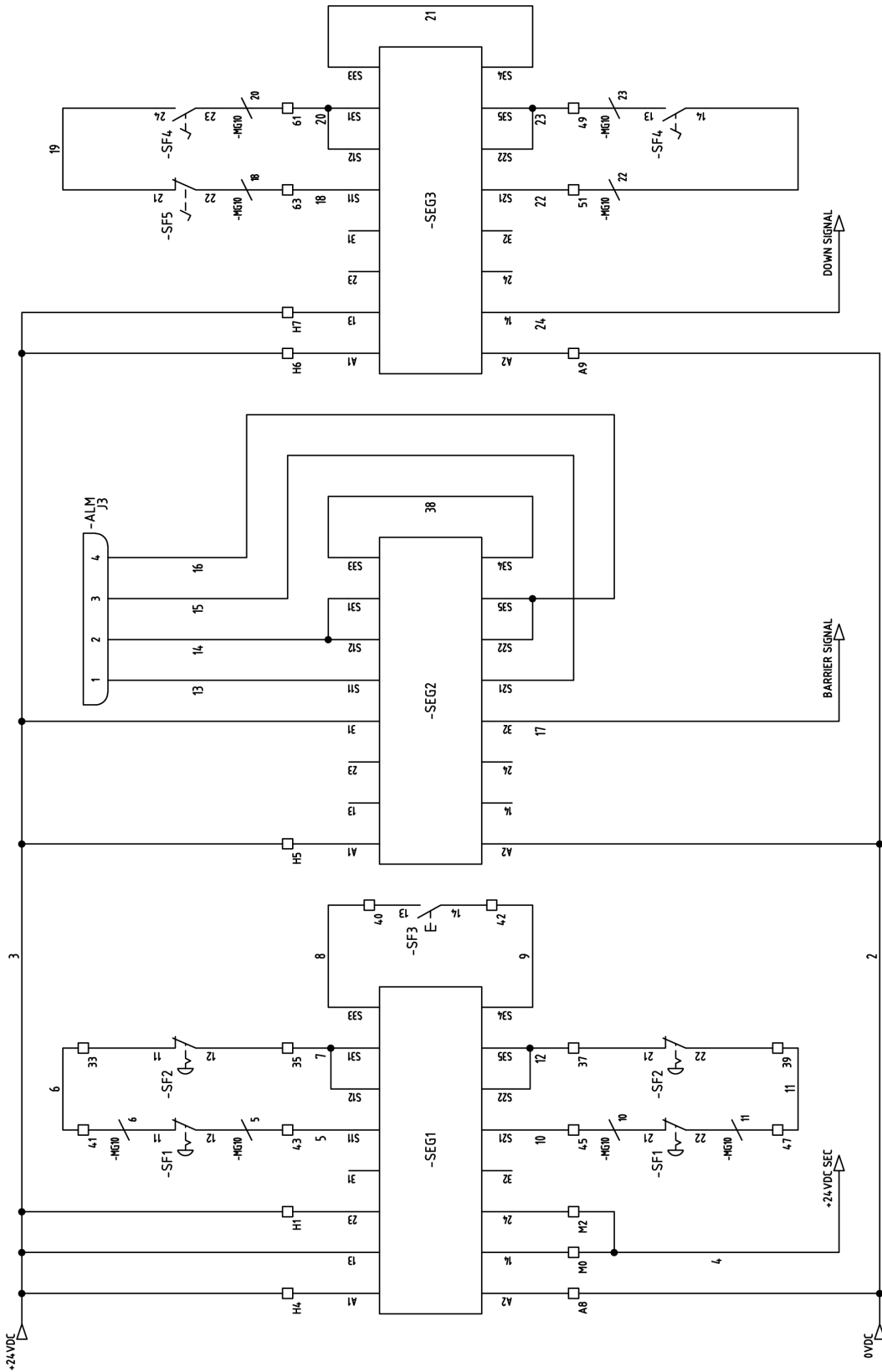

- SF1 : PEDAL EMERGENCY STOP
- SF2 : FRONT EMERGENCY STOP
- SF3 : RESTART BUTTON
- SF4 : DOWN PEDAL
- SF5 : DEAD MAN PEDAL
- ALM: DSP LASER AL MODULE

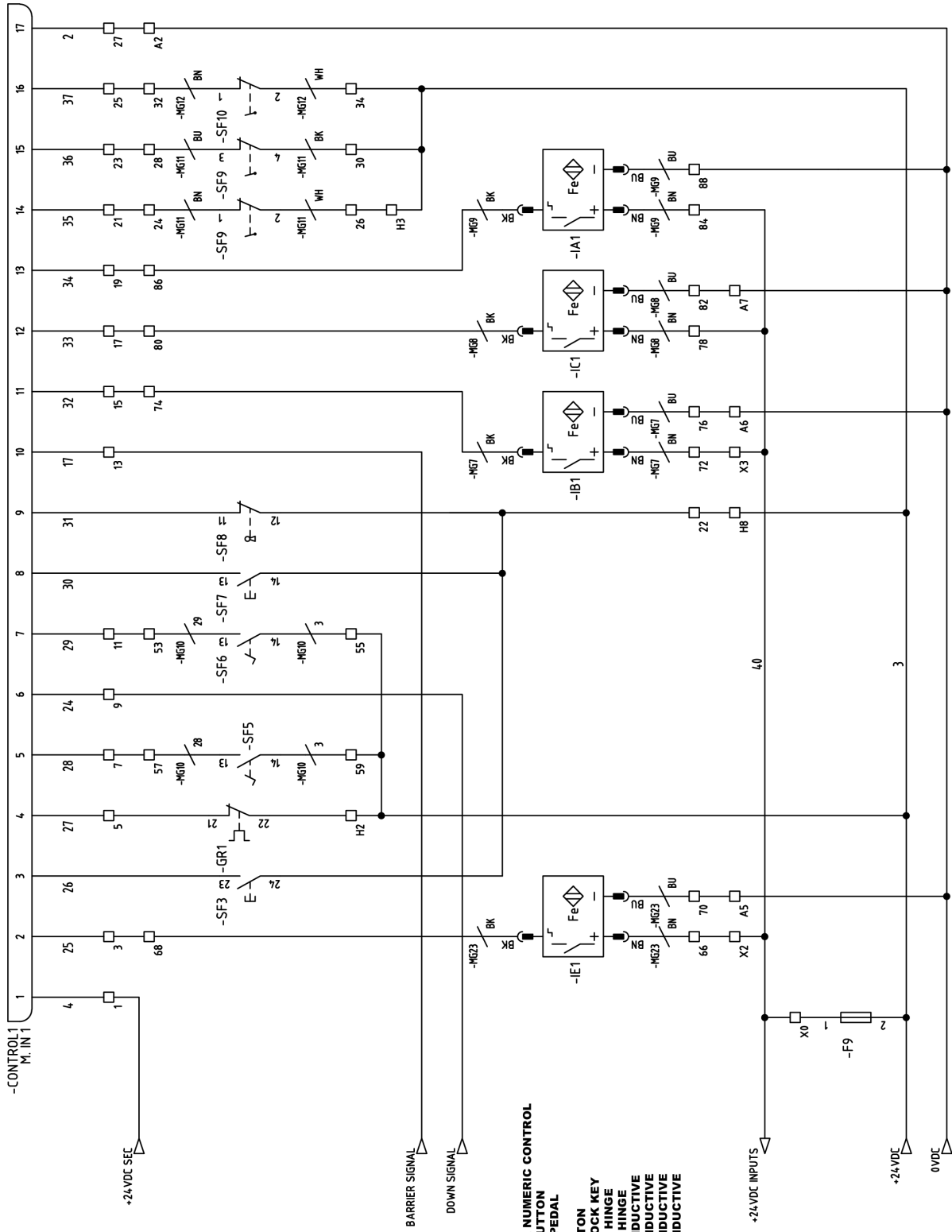

CONTROL 1 : ESA NUMERIC CONTROL
 SF3 : RESTART BUTTON
 SF5 : DEAD MAN PEDAL
 SF6 : UP PEDAL
 SF7 : SPED BUTTON
 SF8 : GENERAL LOCK KEY
 SF9 : RIGHT SIDE HINGE
 SF10 : LEFT SIDE HINGE
 IE1 : ENCODER INDUCTIVE
 IA1 : A1 VALVE INDUCTIVE
 IB1 : B1 VALVE INDUCTIVE
 IC1 : C1 VALVE INDUCTIVE

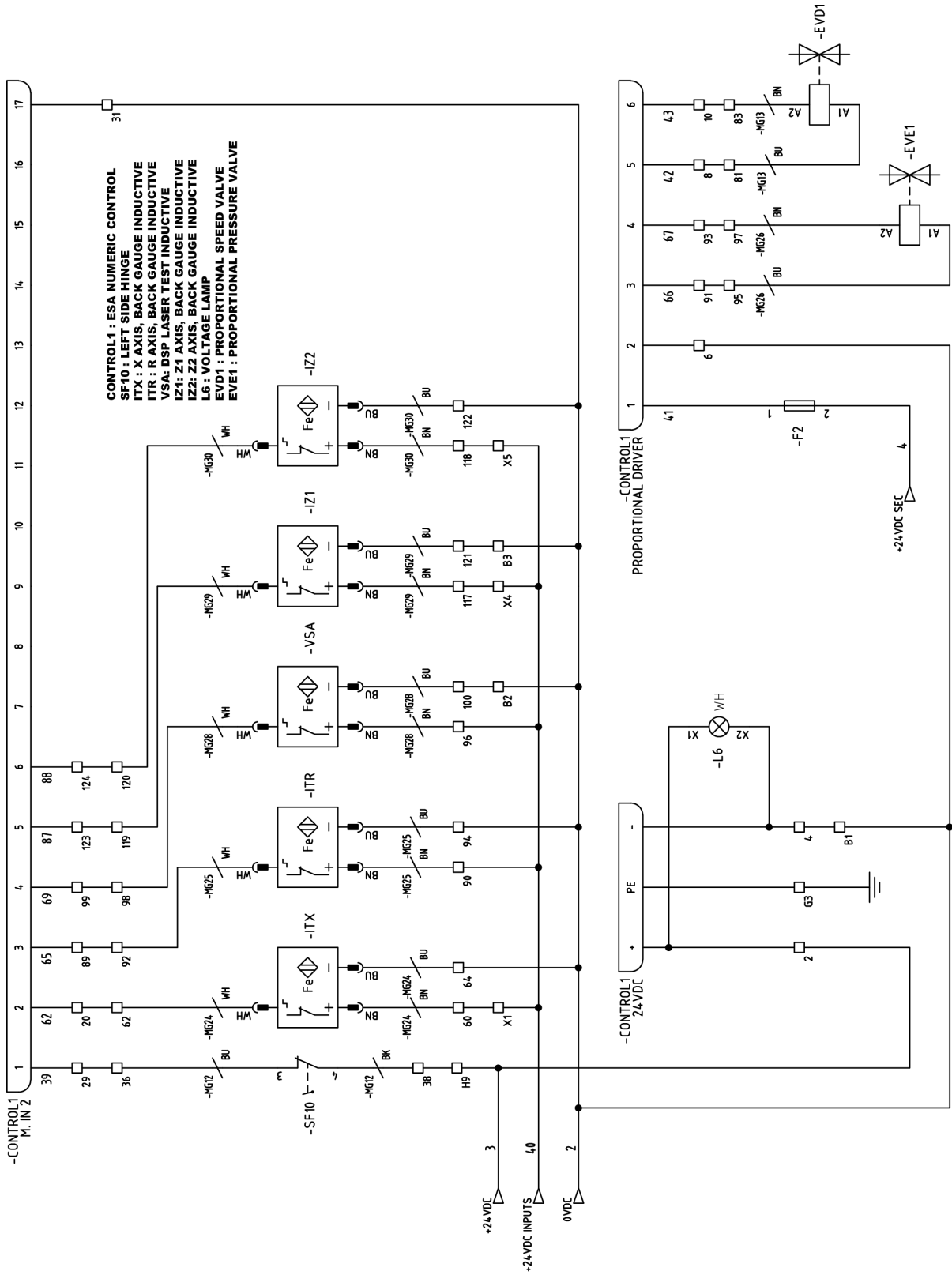

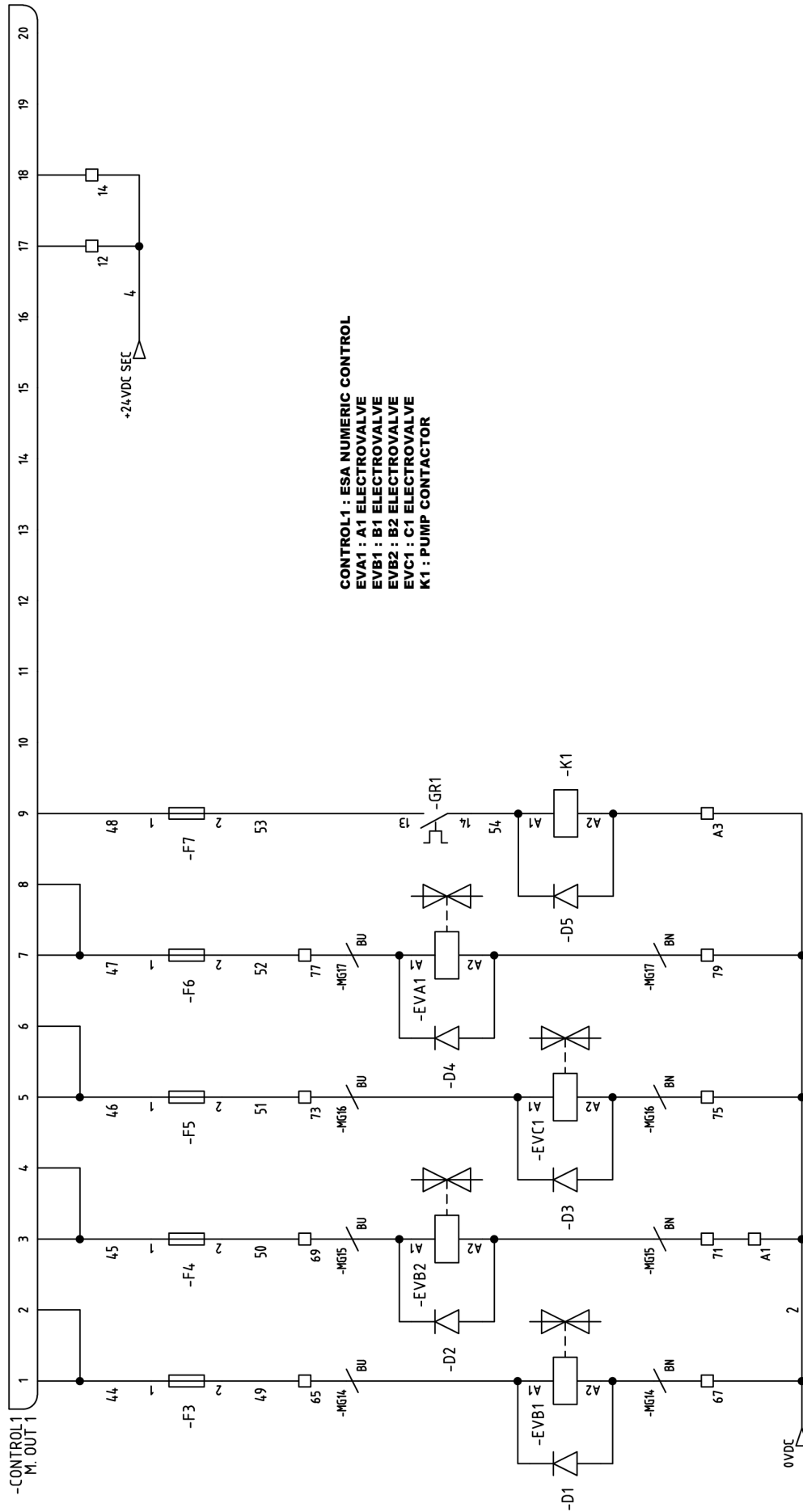

CONTROL 1 : ESA NUMERIC CONTROL
EVA1 : A1 ELECTROVALVE
EVB1 : B1 ELECTROVALVE
EVB2 : B2 ELECTROVALVE
EVC1 : C1 ELECTROVALVE
K1 : PUMP CONTACTOR

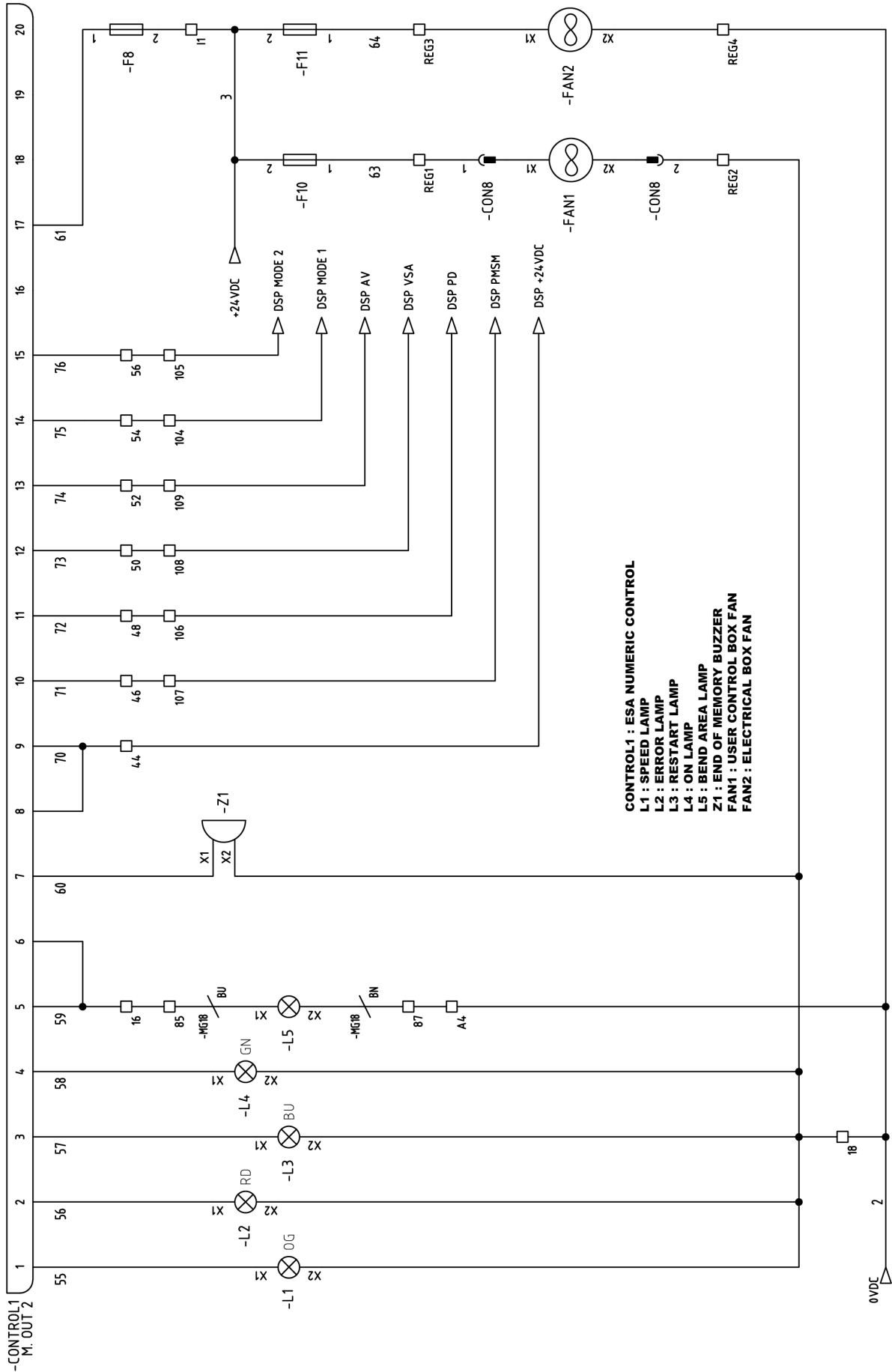

LINEAR ENCODER

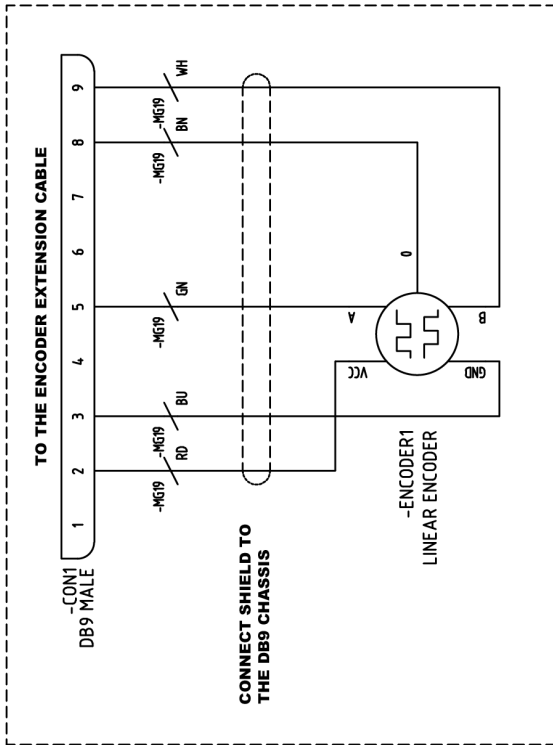

ENCODER EXTENSION CABLE

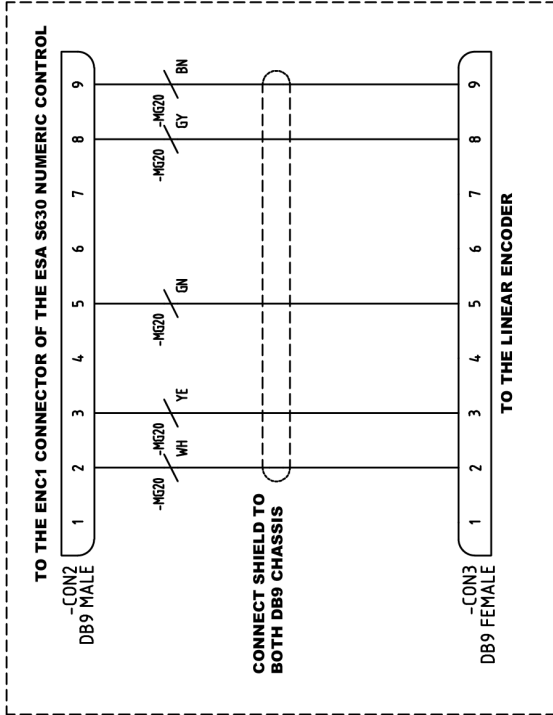

ETHERNET EXTENSION CABLE

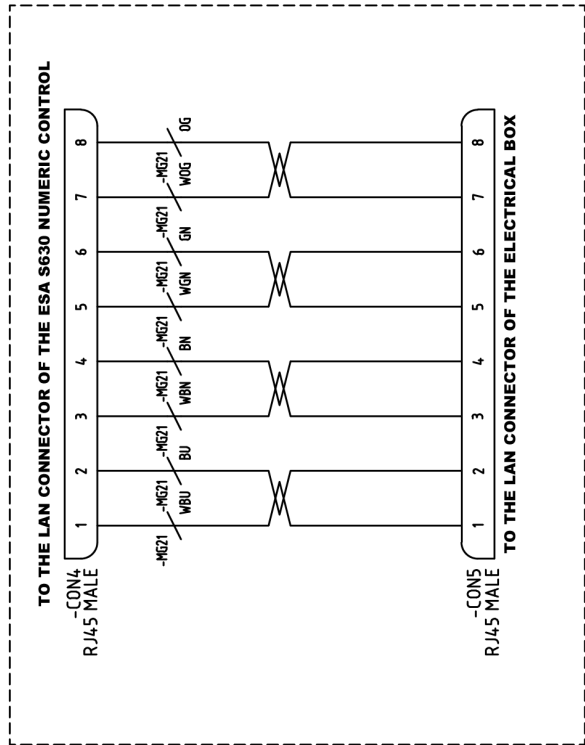

CAN BUS CABLE

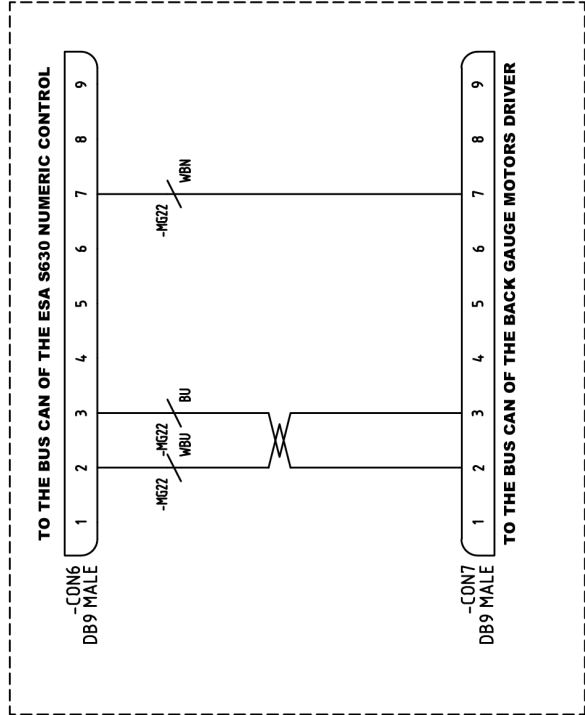

9. Hydraulic map

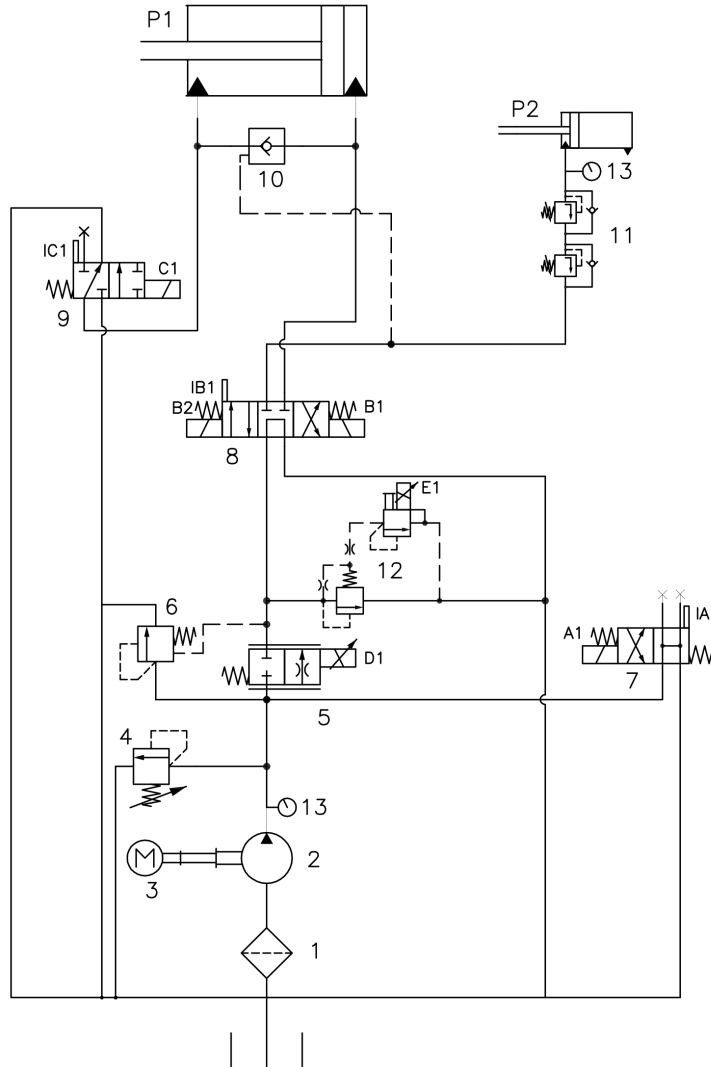

- 1. Filtro
- 2. Bomba hidráulica
- 3. Motor eléctrico
- 4. Limitadora de presión
- 5. Válvula proporcional
- 6. Limitadora compensada
- 7. Electroválvula Bending
- 8. Electroválvula principal
- 9. Electroválvula cambio de velocidad
- 10. Antirretorno pilotado
- 11. Válvulas anticaída
- 12. Válvula reguladora presión
- 13. Manómetro

	A1	B1	B2	C1	D1
SUBIDA	X		X		X
BAJADA RAPIDA	X	X		X	
BAJADA LENTA	X	X			
BAJADA MUY LENTA	X	X			X

OUR RANGE OF MACHINERY



IRON WORKERS



SECTION BENDING MACHINES



NON-MANDREL PIPE BENDER



HORIZONTAL PRESS BRAKE



TWISTING/SCROLL BENDING MACHINES



HYDRAULIC PRESS BRAKES



HYDRAULIC SHEAR MACHINES



GAS FORGES



IRON EMBOSSING MACHINES



END WROUGHT IRON MACHINES



BROACHING MACHINES



POWER HAMMERS



HYDRAULIC FORGING PRESS